



PRODUCT CATALOG

2023-2024



GUN SAFES



HOME SECURITY



PHARMACY SAFES



COMMERCIAL SECURITY



DEPOSITORY SAFES



ELECTRONIC LOCKS

ABOUT US



American Security® has been dedicated to manufacturing high quality, high security safes since 1946. We offer an extensive product line of over 400 standard models of burglary and fire resistant safes in every insurance classification from "B" rate to Underwriter's Laboratories TL-15, TL-30 and TL-30x6.

American Security is the largest and most respected safe manufacturer in the industry because:

- Our dedicated Customer Service Representatives care about you.
- Fully staffed Technical Service Department networked with thousands of factory trained technicians.
- Our Quality Control Department assures that the products we build are the finest in the industry.
- State-of-the-art computer controlled manufacturing equipment helps us meet demanding deadlines and keeps us on the leading edge of technology.
- We are located in a major West Coast distribution point with direct access to all major domestic and international freight services.
- We specialize in developing custom safes to meet specific cash handling requirements for banks, restaurants, supermarkets, convenience stores and many other industries.
- Our Engineering and Design Department is fully staffed and features the most advanced CAD system for rapid creation of sales drawings, design modifications and precise manufacturing blue prints.

For superior asset protection there is only one name you can trust for quality, service and reliability...American Security.

TABLE OF CONTENTS



GUN SAFES

THE RF SERIES	4
THE BFII SERIES GUN SAFES - 120 MINUTE FIRE	5
THE BFX SERIES GUN SAFES - 120 MINUTE FIRE	6
NF SERIES - 90 MINUTE FIRE	7
SF SERIES - 60 MINUTE FIRE	8
TF SERIES - 30 MINUTE FIRE	9
CONCEALED SAFE	10
HANDGUN SECURITY	11
VAULT DOOR	12

GUN SAFE ACCESSORIES

GUN SAFE ACCESSORIES	13
STOR-IT CABINETS	14
THE SAFE CLOAK	14

BF® SERIES SECURITY SAFES

U.L. LISTED FIRE RATED BURGLARY SAFES	15
---------------------------------------------	----

HOME SECURITY

BFS SERIES U.L. & ETL CERTIFIED BURGLARY & FIRE SAFES	16
BFS912E5LP U.L. & ETL CERTIFIED BURGLARY & FIRE SAFE	16
AM SERIES HOME SECURITY SAFES	17

COMMERCIAL SECURITY SAFES

CSC SERIES COMPOSITE SAFES	18
----------------------------------	----

ELECTRONIC SECURITY SAFES

EST SERIES HOME SECURITY SAFES	19
IRC916 IN-ROOM ELECTRONIC SAFE	19

U.L. SERIES

U.L. LISTED 2-HOUR FIRE AND IMPACT SAFES	20
------------------------------------------------	----

IMPORTED U.L. LISTED 1-HR FIRE SAFES

FS SERIES IMPORTED U.L. LISTED 1-HR FIRE SAFES	21
------------------------------------------------------	----

FLOOR SAFES

SUPER BRUTE	22
STAR® ROUND LIFT-OUT DOOR	23
STAR® RECTANGULAR BODY, ROUND LIFT-OUT DOOR	23

WALL SAFES

.....	24
-------	----

UNDERCOUNTER SAFES

.....	25
-------	----

DEPOSITORY SAFES

DS SERIES - "B" RATE ROTARY AND FRONT LOADING	26
-----------------------------------------------------	----

DS SERIES TILL STORAGE DEPOSITORY SAFES	27
MONEY MANAGER SERIES	27
RETAIL MONEY MANAGER SAFES	28
BWB SERIES - WIDE BODY CASH CONTROL	29

TL-15 & TL-30 MONEY CHESTS

ACE U.L. LISTED	38
DXE U.L. LISTED	32

"B" RATE SECURITY SAFES

BWB SERIES AND MS1414	30
-----------------------------	----

"B" AND "C" RATE SECURITY CHESTS

.....	31
-------	----

AMVAULT TL-15 AND TL-30

AMVAULTX6 TL-30X6 HIGH SECURITY SAFE	33
AMVAULT FIRE RATED COMPOSITE SAFES	34
SAFE SPECIFICATIONS	35
UNDERWRITERS LABORATORIES' BURGLARY RATING CLASSIFICATION	35
CEV SERIES COMPOSITE SAFES	36

MAX 15 SERIES COMPOSITE SAFES

.....	35
-------	----

ACF TL-30 SERIES MONEY CHEST

ACF TL-30 U.L. LISTED FIRE RATED MONEY CHEST	39
ACF TL-30 2-HOUR FIRE RATED DEPOSITORY SAFE	39

PHARMACY SAFES

.....	40
-------	----

OPTIONAL EXTRAS

.....	41
-------	----

ELECTRONIC LOCKS

SAFEWIZARD II®	42
ESLAUDIT II	43
ESL5	43
ESL SERIES	44
ROTOBOLT REDUNDANT SAFE LOCK	45
LOCKS FROM KABA	45
ELECTRONIC LOCK COMPARISON CHART	46

MECHANICAL LOCKS AND KEY LOCKS

.....	47
-------	----

FIRE RATINGS

.....	48, 49
-------	--------

BURGLARY RATINGS

.....	50
-------	----

LOCK INDEX

.....	51, 52
-------	--------

INDEX BY MODEL NUMBER

.....	54
-------	----

GUIDE TO SAFE USAGE

.....	55
-------	----

GUN SAFES

THE RF SERIES GUN SAFES - 120 MINUTE FIRE



SECURITY

- 6" Thick High Security Composite Door
- 3½" Thick High Security Body (3" on X6)
- UL Listed TL - 30 or TL - 30X6 High Security Burglary Classification
- Active 3-Way Bolt Work
- 10 Massive 1½" Chrome Plated Bolts
- Anchor holes provided

WARRANTY

- 5-year parts and labor warranty when purchased with a factory installed American Security lock
- Special lifetime warranty for damage from burglary attempts and fire

FIRE PROTECTION

- Seamless DryLight® fill
- 120-Minute Intertek verified fire rating
- Palusol seals to protect against fire and smoke

FUNCTIONALITY

- Storage for long guns
- Door organizer
- LED light kit
- AC power outlet with removable cord
- Industry's most flexible interior

TEXTURED COLORS



Sandstone

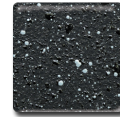

Granite



Textured Black

HARDWARE COLORS



Chrome



Brass



Black Nickel



RF582820X6 in textured black with chrome hardware, ESL10 electronic lock, and right-swung door.

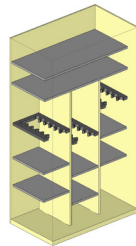

RF703620X6 Interior

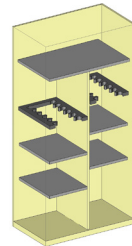

RF582820X6 Interior

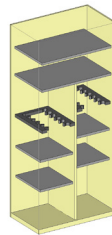

RF6528 Interior



Model	Outside Dimension H" x W" x D"	Inside Dimension H" x W" x D"	Door Clearance H" x W"	Door Thickness	Body Thickness	Interior Capacity	Weight	Lock Type
RF703620X6	76" x 42" x 29-¼"	70 x 36 x 20	70" x 36"	6"	3"	12-12-12-24-36+2 Gun or 58 + 2 Gun	4,578 lbs.	See pg. 52
RF582820X6	64" x 34" x 29-¼"	58 x 28 x 20	58" x 28"	6"	3"	12-12-24 + 2 Gun	3,455 lbs.	See pg. 52
RF6528	72" x 35" x 29-¼"	65 x 28 x 20	65" x 28"	6"	3-½"	12-12-24 + 2 Gun	3,418 lbs.	See pg. 52

GUN SAFES

THE BFII SERIES GUN SAFES - 120 MINUTE FIRE

SECURITY

- Combined steel thickness of nearly 1/2" in body construction
- U.L. Level II RSC burglary classification
- American Security's patented active hardplate
- TL-15 boltwork with 10 massive 1 1/2" chrome plated bolts
- Anchor holes provided

WARRANTY

- 5-year parts and labor warranty when purchased with a factory installed American Security lock
- Special lifetime warranty for damage from burglary attempts and fire

FIRE PROTECTION

- Seamless DryLight® fill
- 120-Minute Intertek verified fire rating
- Dual door seals to protect against fire and smoke

BFII SERIES CONSTRUCTION

11 GA outer steel shell with a combined 5/16" inner steel liner providing a total nearly 1/2" thick steel barrier for added burglary protection

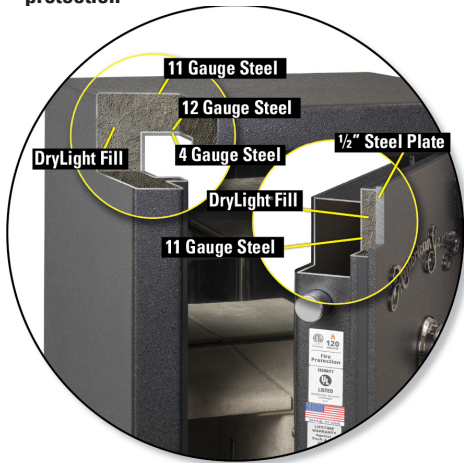

FUNCTIONALITY

- Industry's most flexible interior
- Door organizer
- Storage for long guns on door
- AC power outlet with removable cord
- LED light kit

Notes:

- Any color combination available on request
- Dimensions listed are exterior dimensions. Add 3" on all BF safes to overall depth for lock and handle.

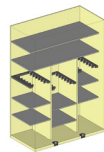

7250 Standard Gun Interior

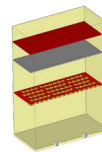

7250 Optional 73 Gun Interior

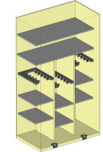

7240 Standard Gun Interior

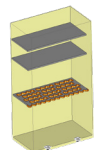

7240 Optional 58 Gun Interior

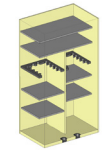

6636 Standard Gun Interior

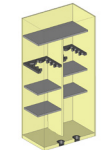

6030 Optional Gun Interior

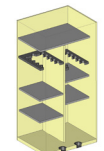

6032 Standard Gun Interior

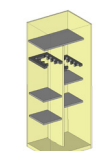

6024 Standard Gun Interior



HIGH GLOSS COLORS



TEXTURED COLORS



HIGH GLOSS/TEXTURED COLOR

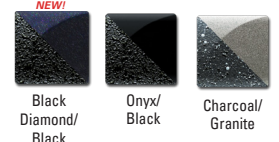

HARDWARE COLORS

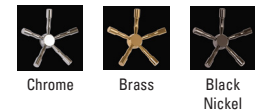

BFII6030 shown in High Gloss Onyx with chrome hardware and ESL 10 electronic lock

Model	Outside Dimension H" x W" x D"	Inside Dimension H" x W" x D"	Door Clearance H" x W"	Door Thickness	Body Thickness	Interior Capacity	Weight	Lock Type
BFII7250	71-1/4 x 50 x 28	66-3/4 x 45-1/2 x 20-3/4	63-3/4 x 42-5/16	4-3/4 / 1/2	2 1/4	14-14-14-28-42 + 2 Gun or 73 + 2 Gun	2,438 lbs.	See pg. 52
BFII7240	71-1/4 x 40 x 26	66-3/4 x 35-1/2 x 18-3/4	63-3/4 x 32-5/16	4-3/4 / 1/2	2 1/4	12-12-12-24-36 + 2 Gun or 58 + 2 Gun	1,991 lbs.	See pg. 52
BFII6636	65-1/4 x 36 x 26	60-3/4 x 31-1/2 x 18-3/4	57-3/4 x 28-5/16	4-3/4 / 1/2	2 1/4	12-12-24 + 2 Gun	1,716 lbs.	See pg. 52
BFII6030	59-1/4 x 30 x 26	54-3/4 x 25-1/2 x 18-3/4	51-3/4 x 22-5/16	4-3/4 / 1/2	2 1/4	11-11-22 + 2 Gun	1,395 lbs.	See pg. 52
BFII6032	59-1/4 x 30 x 21	54-3/4 x 25-1/2 x 13-3/4	51-3/4 x 22-5/16	4-3/4 / 1/2	2 1/4	9-9-18 + 2 Gun	1,244 lbs.	See pg. 52
BFII6024	59-1/4 x 24 x 21	54-3/4 x 19-1/2 x 13-3/4	51-3/4 x 16-5/16	4-3/4 / 1/2	2 1/4	8-8-16 Gun + 1 Gun	1,067 lbs.	See pg. 52

GUN SAFES

THE BFX SERIES GUN SAFES - 120 MINUTE FIRE



SECURITY

- Active 4X locking system:
 1. ¼" hardplate and a top-rated hardened disc defeats lock attacks
 2. Spring loaded relock mechanism
 3. Gear cam housing with precision engineered lock bolt protection
- Four-way active bolt work (BFX6024 has two-way bolt work)
- U.L. Level I RSC burglary classification
- 10, 14, and 16 massive ½" chrome plated bolts
- Anchor holes provided

WARRANTY

- 5-year parts and labor warranty when purchased with a factory installed American Security lock
- Special lifetime warranty for damage from burglary attempts and fire

FIRE PROTECTION

- Seamless DryLight® fill
- 120-minute Intertek verified fire rating
- Dual door seals to protect against fire and smoke

FUNCTIONALITY

- Industry's most flexible interior
- Door organizer
- Storage for two long guns on door (1 on BFX6024)
- Spy-proof, key-locking dial with decorative five-spoke handle and a convenient pull handle. (BFX6024 offers a tri-spoke handle and does not come with a pull handle)
- Mirrored back wall for added interior visibility
- AC power outlet with removable cord
- LED light kit

HIGH GLOSS COLORS



TEXTURED COLORS

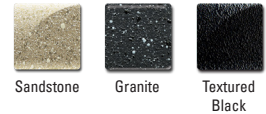

HIGH GLOSS/TEXTURED COLOR

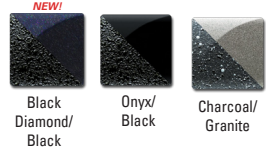

HARDWARE COLORS

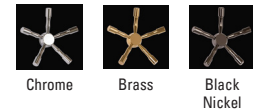

NOTE: ALL MODELS AVAILABLE WITH OPTIONAL FINIALS IN ALL HARDWARE COLORS

BFX SERIES CONSTRUCTION

11 GA outer steel shell with 12 GA inner steel liner totaling approx. ¼" steel barrier

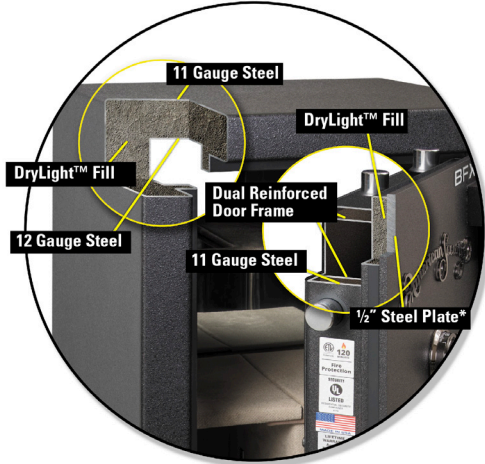

BFX6636 shown in NEW High Gloss/Textured Black Diamond with chrome hardware

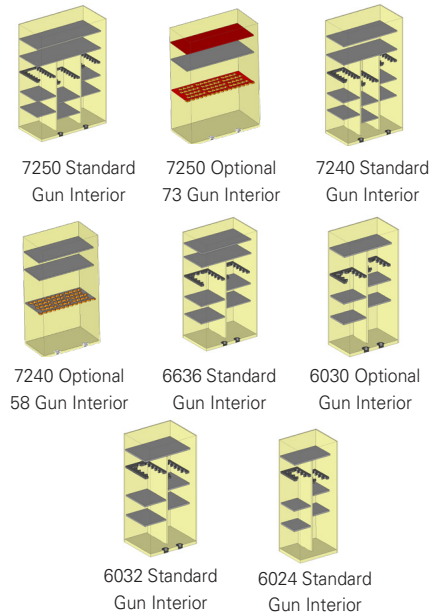

ACTIVE 4X
LOCKING SYSTEM

Model	Outside Dimension H" x W" x D"	Inside Dimension H" x W" x D"	Door Clearance H" x W"	Door Thickness	Body Thickness	Interior Capacity	Weight	Lock Type
BFX7250	71-¼ x 50 x 28	65-⅞ x 46 x 21	63-¾ x 42-⅝	4-⅝ / ⅜	2	14-14-14-28-42 + 2 Gun or 73 + 2 Gun	1,789 lbs.	See pg. 52
BFX7240	71-¼ x 40 x 26	65-⅞ x 36 x 19-½	63-¾ x 32-⅝	4-¾ / ½	2	12-12-12-24-36 + 2 Gun or 58 + 2 Gun	1,585 lbs.	See pg. 52
BFX6636	65-¼ x 36 x 26	61-⅞ x 32 x 19-⅞	57-¾ x 28-⅝	4-¾ / ½	2	12-12-24 + 2 Gun	1,319 lbs.	See pg. 52
BFX6030	59-¼ x 30 x 26	53 x 26 x 19-½	51-¾ x 22-⅝	4-¾ / ½	2	11-11-22 + 2 Gun	1,036 lbs.	See pg. 52
BFX6032	59-¼ x 30 x 21	53 x 26 x 14	51-¾ x 22-⅝	4-¾ / ½	2	9-9-18 + 2 Gun	913 lbs.	See pg. 52
BFX6024	59-¼ x 24 x 21	53 x 20 x 14	51-¾ x 16-⅝	4-⅝ / ⅜	2	8-8-16 Gun + 1 Gun	720 lbs.	See pg. 52

GUN SAFES

NF SERIES - 90 MINUTE FIRE



The American Security® NF Gun Safe offers both superior performance and value. For burglary protection, it has a stout ¼"-thick steel plate in the door. For fire protection, it is lined with 3 to 4 layers of drywall that are strategically engineered for optimal fire protection. This enables the NF Gun Safe to pass a verified 90-minute fire test at Intertek, an independent testing laboratory.

SECURITY

- Four-way bolt work
- U.L. Level I RSC burglary classification (1-man, 5-minute test. Utilizes tools typically found in a household)
- 14 massive 1-½" chrome plated bolts
- Anchor holes provided
- U.L.-Listed ESL5 electronic lock with illuminated keypad
- Decorative five-spoke handle

FIRE PROTECTION

- Lined with three to four layers of drywall
- 90-minute Intertek verified fire rating
- Dual door seals to protect against fire and smoke

FUNCTIONALITY

- Industry's most flexible interior
- Door organizer
- Storage for two long guns on door (1 on NF5924E5)
- AC power outlet with removable cord

COLOR(S):

Gunmetal gray (GY) with black nickel hardware (LTN)

Dimensions listed are exterior dimensions. Add 3" to overall depth for lock and handle.

NF SERIES CONSTRUCTION

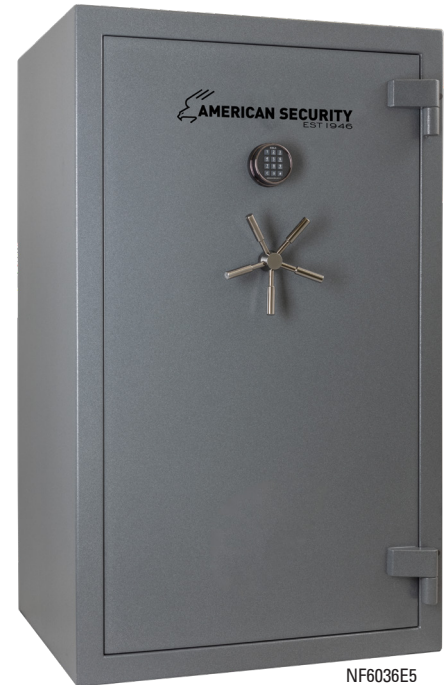
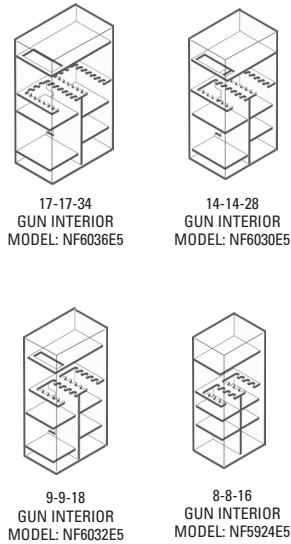
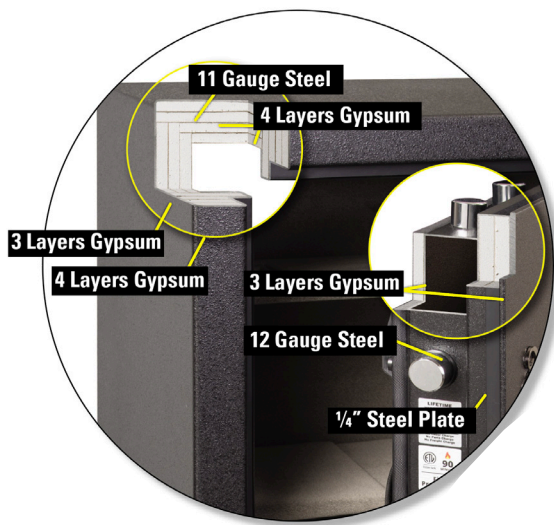

Model	Outside Dimension H" x W" x D"	Inside Dimension H" x W" x D"	Door Clearance H" x W"	Door Thickness	Body Thickness	Interior Capacity	Weight	Lock Type
NF6036E5	59 x 36 x 26	53-½ x 31-⅝ x 18-¼	52 x 28-¾	4-¼ / ¼	2-3/16"	17-17-34 + 2 Gun	977 lbs.	ESL5
NF6030E5	59 x 30 x 26	53-½ x 25-⅝ x 18-¼	52 x 22-¾	4-¼ / ¼	2-3/16"	14-14-28 + 2 Gun	788 lbs.	ESL5
NF6032E5	59 x 30 x 21	53-½ x 25-⅝ x 13-¼	52 x 28-¾	4-¼ / ¼	2-3/16"	9-9-18 + 2 Gun	761 lbs.	ESL5
NF5924E5	59 x 24 x 18	53-½ x 19 x 10	52 x 16-¾	4-¼ / ¼	2-3/16"	8-8-16 Gun + 1 Gun	600 lbs.	ESL5

SF SERIES - 60 MINUTE FIRE



The American Security® SF GUN SAFE offers both performance and value. For burglary protection, it has a stout 3/16" - thick steel plate door. For fire protection, it is lined with 3 to 4 layers of drywall that are strategically engineered for optimal fire protection. This enables the SF Gun Safe to pass a verified 60-minute fire test at Intertek, an independent testing laboratory.

SECURITY

- Four-way bolt work
- 14 massive 1-1/4" chrome plated bolts
- Anchor holes provided

FIRE PROTECTION

- Lined with three to four layers of drywall
- 60-minute Intertek verified fire rating
- Dual door seals to protect against fire and smoke

FUNCTIONALITY

- U.L.-listed ESL5 electronic lock with illuminated keypad
- Decorative three-spoke handle
- Industry's most flexible interior
- Door organizer
- Storage for two long guns on door

COLOR(S):

Textured black (BK) with black nickel hardware (LTN)

Dimensions listed are exterior dimensions. Add 3" to overall depth for lock and handle.



SF6030

SF SERIES CONSTRUCTION

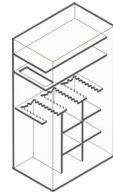
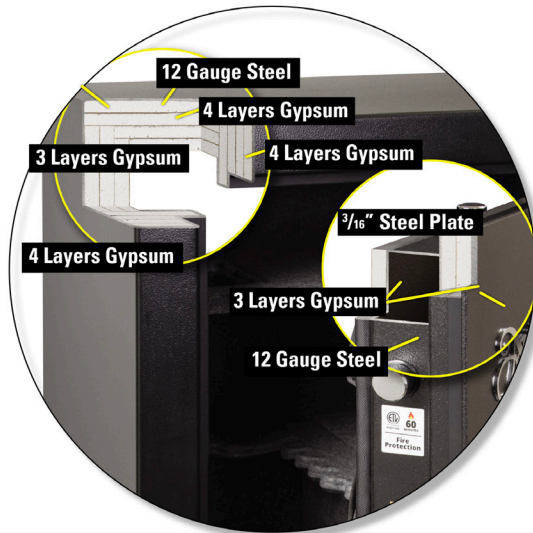

15-15-5-30-40
GUN INTERIOR
MODEL: SF7240E5

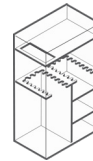

17-17-34
GUN INTERIOR
MODEL: SF6036E5

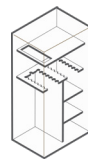

15-15-30
GUN INTERIOR
MODEL: SF6030E5

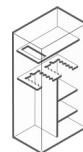

11-11-22
GUN INTERIOR
MODEL: SF6032E5

Model	Outside Dimension H" x W" x D"	Inside Dimension H" x W" x D"	Door Clearance H" x W"	Door Thickness	Body Thickness	Interior Capacity	Weight	Lock Type
SF7240E5	72 x 40 x 26	66-1/2 x 36 x 19	63-1/2 x 31-1/2	3-5/8 / 3/16	2	15-15-15-30-40 + 2 Gun	1,086 lbs.	ESL5
SF6036E5	59 x 36 x 26	53-1/2 x 32 x 19	50-1/2 x 27-1/2	3-5/8 / 3/16	2	17-17-34 + 2 Gun	840 lbs.	ESL5
SF6030E5	59 x 30 x 26	53-1/2 x 26 x 19	50-1/2 x 21-1/2	3-5/8 / 3/16	2	15-15-30 + 2 Gun	748 lbs.	ESL5
SF6032E5	59 x 30 x 21	53-1/2 x 26 x 15	50-1/2 x 21-1/2	3-5/8 / 3/16	2	11-11-22 + 2 Gun	662 lbs.	ESL5

GUN SAFES

TF SERIES - 30 MINUTE FIRE



SECURITY

- Four-way bolt work
- (14) 1-1/4" chrome plated bolts on TF5924E5
- (8) 1" chrome plated bolts on TF5517E5
- Anchor holes provided
- U.L.-listed ESL5 electronic lock with illuminated keypad

FIRE PROTECTION

- Lined with two layers of drywall on the ceiling and door
- Lined with one layer of drywall in all the walls
- 30-minute factory fire label
- Dual door seals to protect against fire and smoke

FUNCTIONALITY

- Decorative three-spoke handle on TF5942E5, "L" style handle on TF5517E5.
- Industry's most flexible interior
- Door organizer
- TF5924 has storage for one long gun on the door



TF5924E5

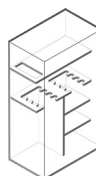

8-8-16
GUN INTERIOR
MODEL: TF5924E5

COLOR(S):

Textured black (BK) with black nickel hardware (LTN)

Dimensions listed are exterior dimensions. Add 3" to overall depth for lock and handle.



TF SERIES CONSTRUCTION

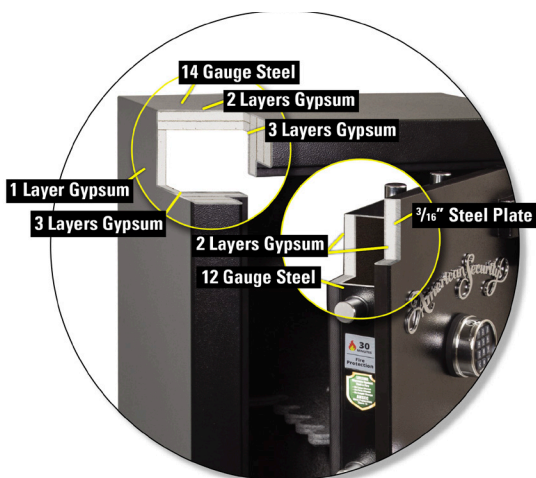

TF5517E5



11
GUN INTERIOR
MODEL: TF5517E5



Model	Outside Dimension H" x W" x D"	Inside Dimension H" x W" x D"	Door Clearance H" x W"	Door Thickness	Body Thickness	Interior Capacity	Weight	Lock Type
TF5924E5	59 x 24 x 18	56-1/2 x 22 x 15	52 x 16-3/4	3-5/8 / 3/16	1(*)	8-8-16 Gun + 1 Gun	388 lbs.	ESL5
TF5517E5	55-1/4 x 17-3/4 x 16	52-1/2 x 16 x 13	49-1/2 x 12	3-1/4 / 3/16	1(*)	11 Gun	286 lbs.	ESL5

CONCEALED SAFE



American Security®'s UBS648 was produced from our culture of listening to customers. Customers wanted a secure place to store their home defense weapons. Sleek and compact, the UBS648 can be secured to either the floor or back of an SUV and is equipped with our backlit U.L.-Listed ESL5-LP lock, which offers a silent stealth-mode option and was specifically designed for this product.

FEATURES

- Tilt-out door for easy access
- Foam padded slide-out gun tray
- UL-Listed ESL5-LP Electronic lock with backlit and stealth mode keypad
- 18 GA & 7 GA steel construction
- 4-point locking bar
- 4 mounting holes on the top and bottom of safe
- Side handles with cutouts to attach straps or security cables
- Mini flashlight with flashlight holder

COLOR(S): Textured black



ESL5-LP



Model	Outside Dimension H" x W" x D"	Inside Dimension H" x W" x D"	Door Clearance H" x W"	Door Thickness	Body Thickness	Interior Capacity	Weight	Lock Type
UBS648	6 x 48 x 14- ⁵ / ₈ "	3- ¹ / ₂ x 44- ¹ / ₂ x 13- ⁵ / ₈ "	13 x 44- ¹ / ₂ "	1- ¹ / ₈ "	1/16"	1.50 cu. ft.	80 lbs.	ESL5LP

HANDGUN SECURITY



PS1210HD



PS1208EZ



HAS410



Model	Outside Dimension H" x W" x D"	Inside Dimension H" x W" x D"	Door Clearance H" x W"	Door Thickness	Body Thickness	Interior Capacity	Weight	Lock Type
PS1210HD	10- ¹ / ₄ x 12- ¹ / ₅ x 4- ¹ / ₄	9- ⁵ / ₈ x 11- ⁵ / ₈ x 2- ⁷ / ₁₆	9- ⁵ / ₈ x 11- ⁵ / ₈	³ / ₁₆	10 GA	273 cu. in.	24 lbs.	Simplex Mechanical Push Button
PS1208EZ	8- ¹ / ₈ x 12 ¹ / ₄ x 4	7- ³ / ₄ x 11- ³ / ₄ x 2- ⁷ / ₁₆	7- ³ / ₄ x 11- ³ / ₄	14 GA	14 GA	222 cu. in.	11 lbs.	Simplex Mechanical Push Button
HAS410	12 x 10 x 4	9- ³ / ₄ x 7- ¹ / ₄ x 2- ⁷ / ₁₆	10- ⁹ / ₁₆ x 7- ¹ / ₄	³ / ₁₆	10 GA	172 cu. in.	20 lbs.	Simplex Mechanical Push Button

VAULT DOOR



VD8036BF



American Security®'s Vault Doors offer the same protection as our innovative BF® Safes. They are designed to fit standard 80" x 30", 80" x 36" and 80" x 42" door openings. With our inward-swinging vault door option, your vault room can also serve as a storm shelter. The vault door's inward swing ensures that you will be able to open the door even if debris has fallen on the other side. All American Security vault doors can be opened from the inside, ensuring personal safety.

STANDARD FEATURES:

- 2" thick door
- 10 1/2" chrome plated bolts (5 bolts on inswing doors)
- Adjustable frame to fit walls ranging from 4 3/4" to 9 1/2" thick
- Safety lock release
- Spy-proof key-locking dial
- 1 year parts and labor warranty

BF SERIES VAULT DOOR FEATURES:

- 1/2" steel plate on face of door

- 1 3/8" of seamless DryLight® as fire protection

BFQ SERIES VAULT DOOR FEATURES:

- 1/4" steel plate on face of door
- 1 3/8" of seamless DryLight as fire protection

OPTIONAL FEATURES:

- Left-swing door available

COLOR(S): Comes standard in Textured Black. Please refer to price book for pricing on premium colors.

Model	Swing Type	Wall Opening H" x W"	Door Opening H" x W"	Weight (Door Only)	Shipping Weight	Lock Type
VD8030BFQ	Out-Swing	79-1/2 x 29-1/2	77-1/2 x 24-3/4	506 lbs.	650 lbs.	See page 52
VD8030BFQIS	In-Swing	79-1/2 x 29-1/2	77 x 20-3/8	480 lbs.	634 lbs.	See page 52
VD8030BF	Out-Swing	79-1/2 x 29-1/2	77-1/2 x 24-3/4	695 lbs.	839 lbs.	See page 52
VD8030BFIS	In-Swing	79-1/2 x 29-1/2	77 x 20-3/8	672 lbs.	816 lbs.	See page 52
VD8036BFQ	Out-Swing	79-1/2 x 35-1/2	77-1/2 x 31	592 lbs.	762 lbs.	See page 52
VD8036BFQIS	In-Swing	79-1/2 x 35-1/2	77 x 26-1/4	556 lbs.	726 lbs.	See page 52
VD8036BF	Out-Swing	79-1/2 x 35-1/2	77-1/2 x 31	819 lbs.	989 lbs.	See page 52
VD8036BFIS	In-Swing	79-1/2 x 35-1/2	77 x 26-1/4	792 lbs.	957 lbs.	See page 52
VD8042BF	Out-Swing	79 1/2 x 41 1/2	77 1/2 x 37	943 lbs.	1139 lbs.	See page 52
VD8042BFIS	In-Swing	79 1/2 x 41 1/2	77 x 32 1/4	912 lbs.	1098 lbs.	See page 52
VD8042BFQ	Out-Swing	79 1/2" x 41 1/2"	77-1/2" x 37"	678 lbs.	874 lbs.	See page 52
VD8042BFQIS	In-Swing	79-1/2" x 41-1/2"	77" x 32-1/4"	632 lbs.	818 lbs.	See page 52

GUN SAFE ACCESSORIES

LIGHT KITS



8" COMPACT LIGHT KIT

Provides greater visibility inside smaller American Security® safes. Features two 8" light strips with high-intensity white LED lights and a motion sensor that automatically turns the lights on when motion is detected. The lights turn off 30 seconds after motion has stopped. This light kit can be installed on any American Security safe. Includes battery pack. Retrofit Only.



36" LED LIGHT KIT

Has two 36" light strips with high-intensity white LED lights and a motion sensor that automatically turns the lights on when motion is detected. The lights turn off 30 seconds after motion has stopped. This light kit can be installed on any American Security safe and is also available as a retrofit kit.

JEWELRY DRAWER



SMALL DRAWER

Velvet lined jewelry drawer that can be installed on top or underneath most shelves.

- 7" x 1 1/2" x 3 5/8"



LARGE DRAWER

Velvet lined jewelry drawer that can be installed on top or underneath most shelves.

- 10" x 13 13/16" x 3 3/4"

PREMIUM UPGRADE PACKAGE



When you choose to upgrade your American Security RF, BFX, BFII, NF or SF Series with a Premium Package, we'll add on some of our most popular options, including the Dehumidifier Rod, a Jewelry Drawer, an LED light kit*, and a 3-outlet power strip with USB. (*LED light kit standard on BFX or BFII gun safes).

OTHER OPTIONS



"AR" RACK

"AR" gun racks are fully adjustable and custom fit in the side shelf area of each "BF" series gun safe. Each rack is designed with enough clearance to accommodate extra large front sights or optics.



PISTOL RACK

Ideal for organizing pistols inside your safe. This four gun pistol rack sits on top of an interior shelf.

Available while Supplies Lasts



DEHUMIDIFIER ROD

Will constantly guard your guns against the threat of rust, pitting and moisture damage. Electrical access is required.



POWER STRIP

3 outlet power strip with two USB ports.



.50 CALIBER HANDLE

5-spoke handle. Available in black nickel only.



DESICCANT

Prevents rust and moisture damage. Recommended for safes without electrical access.

GUN SAFE ACCESSORIES

STOR-IT CABINETS

These elegant, well-appointed 2-Drawer and 4-Drawer Interior Chests are finely crafted in solid-wood maple drawer fronts and maple veneer and finished in a rich honey maple stain. Recessed drawer pulls give these cabinets a more streamlined appearance and makes for an easier fit into a variety of American Security® safes. All drawers are elegantly lined in a silky, dark red felt with heavy-duty, ball-bearing drawer glides and include a variety of organizer inserts. Each insert can be removed for easy viewing, selecting and protection of your jewelry.

2-DRAWER OPTION

- Top drawer includes a three compartment ring organizer and a seven compartment jewelry organizer. Bottom drawer can be used for bulky items or converts to a file drawer
- Outside dimensions: 16 ½" x 15 ⅞" x 14"
- Weight: 32 lbs.

4-DRAWER OPTION

- Top drawer features a three compartment ring organizer and a seven compartment jewelry organizer. Drawer two features a three compartment necklace organizer. Drawer three features a four compartment watch organizer. Drawer four can be used for bulky items
- Outside dimensions: 16 ½" x 15 ⅞" x 14"
- Weight: 38 lbs.

AVAILABLE IN THE FOLLOWING SAFE MODELS:

- **GUN SAFES:** BFX7250*, BFX7240, BFX6636, BFX6030, BFII7250*, BFII7240, BFII6636, BFII6030
- **BURGLARY/FIRE SAFES:** BF1716*/BF3416*
- **CE AND CF MODELS:** 2518*, 3524*, 4524*, 5524*, 6528*, 7236*
- **CSC MODELS:** CSC3018*, CSC4520*

*No kit needed. Cabinets slide right in.



2-DRAWER



4-DRAWER

THE SAFE CLOAK

Instantly disguise your gun safe with American Security's Safe Cloak. Available in five different sizes, the Safe Cloak fits over your gun safe to instantly disguise it as a wood cabinet. Strong magnets and a sewn-in PVC board at the top easily and securely hold the cloak in place. The thermal-transfer, four-color wood-cabinet print is so good, it will fool not only passersby, but guests as well.

AVAILABLE IN THE FOLLOWING SIZES:

- 6024, 6030, 6636, 7240, 7250



BF® SERIES SECURITY SAFES

BF® SERIES U.L. LISTED FIRE RATED BURGLARY SAFES



The American Security® BF® SERIES offers a unique design that combines all the security features of a burglary safe and the peace of mind achieved with a fire safe. The industry's first U.L. Listed, fire-rated burglary safe offers an affordable solution when burglary and fire protection are an essential part of your buying decision!

During Underwriter's Laboratories grueling testing procedures, the BF SERIES earned the U.L. Listed Class 350°F One Hour Fire Label and the (RSC) Residential Security Container Burglary Label.

FEATURES

- **INTUMESCENT DOOR SEAL:** When the intumescent seal is exposed to high temperature (above 250°F), it expands to as much as 8 times its original thickness. In this expanded or reactive state, it has very high thermal insulating capacity and resistance to breakdown. This provides a strong positive seal between the door and body, preventing heat influx
- U.L. 1-Hr. 350°F fire rating. Tested at temperatures up to 1700°F (Except BF3416)

- ETL certified 60-minute fire protection on BF3416

DOOR

- Dual seal design utilizes a silicone foam seal with a heat-expanding Palusol intumescent seal
- U.L.-listed Group II lock with spring-loaded auxiliary relock device
- ¼" heavy duty carburized hardplate

BODY

- 2½" thick, consisting of ½" outer and inner steel plates creating a burglary resistant structure enclosing a unique proprietary fire resistant material
- Three massive 1" diameter solid steel chrome plated locking bolts. A full length dead bar locks deep into the body preventing door removal during a forced entry attempt
- Heavy duty steel hinges provide easy smooth door operation
- One recessed anchor bolt hole and mounting hardware are provided to securely anchor safe
- Plush velour interior
- BF1512, BF1716, BF2116 have one shelf. BF3416 has two shelves.

- Attractively accented with a brass, chrome or black nickel handle.
- Available in several durable and attractive textured or high gloss finishes
- Optional electronic locks are available. See page 51.
- Optional storage cabinets available on models BF3416 and BF1716. See page 40.
- Optional BF Safe Pedestals available. Designed to carry weight and be secure, these heavy-duty risers place your "BF" security safe at a convenient height

Color:

colors come in standard charcoal gray. Please refer to price book for pricing on premium colors.

High-Gloss exterior colors:

Burnt orange (BO), pearl essence (PE), platinum metallic (PL), charcoal metallic (CM), onyx (OX), lazer red (LR), sapphire blue (SR).

Textured exterior colors:

Granite (GR), Sandstone (ST), Black (BK)

Bolt down kit included. Add 2" for dial and handle.



BF2116



BF1716

BF® Safes Lifetime Replacement Warranty:

The best warranty in the business. Lifetime fire replacement and one year parts and labor. Just return the safe freight prepaid to the factory accompanied with the fire report. Contact your dealer for further details.

Model	Outside Dimension H" x W" x D"	Inside Dimension H" x W" x D"	Door Clearance H" x W"	Door Thickness	Body Thickness	Interior Capacity	Weight	Lock Type
BF1512	20-¼ x 17-¼ x 18-¾	15 x 12 x 13	15 x 12	3-½	2-½	2,340	288 lbs.	U.L. listed Group II
BF1716	22-¼ x 21-¾ x 21-¾	17 x 16-½ x 16	17 x 16-½	3-½	2-½	4,488	412 lbs.	U.L. listed Group II
BF2116	26-¼ x 21-¾ x 20-¼	21 x 16-½ x 14-½	21 x 16-½	3-½	2-½	5,024	476 lbs.	U.L. listed Group II
BF3416 †	39-¼ x 21-¾ x 21-¾	34 x 16-½ x 16	34 x 16-½	3-½	2-½	8,976	690 lbs.	U.L. listed Group II

† ETL Certified 60-minute fire rating.

BFS SERIES U.L. & ETL CERTIFIED BURGLARY & FIRE SAFES



STANDARD FEATURES

- ETL verified fire protection of 1200° F for 60 minutes
- U.L. residential security container (RSC) burglary classification
- One anchor hole with hardware
- Unique fire resistant barrier
- ESL10 UL Type high security lock
- 3-way & 4-way bolt work
 - BFS2214 – 3-way active bolt work, or 7 active bolts
 - BFS2815, BFS3416, & BFS4520 – 4-way active bolt work, or 10 active bolts



COLOR(S): Durable and attractive black body with gray door.

Model	Outside Dimension H" x W" x D"	Inside Dimension H" x W" x D"	Door Clearance H" x W"	Door Thickness	Body Thickness	Cubic Capacity	Weight	Lock Type
BFS1512E1	20- ¹ / ₈ x 17- ¹ / ₈ x 19- ³ / ₈	15- ¹ / ₄ x 12- ¹ / ₂ x 12- ³ / ₄	14- ⁷ / ₈ x 12	4- ⁵ / ₈	2- ⁵ / ₁₆	2,430	278 lbs.	ESL10
BFS2214E1	27- ¹ / ₈ x 19- ¹ / ₈ x 21- ³ / ₄	22- ¹ / ₄ x 14- ¹ / ₂ x 15	21- ⁷ / ₈ x 13- ⁷ / ₈	4- ⁵ / ₈	2- ⁵ / ₁₆	4,839	424 lbs.	ESL10
BFS2815E1	33 x 20 x 22- ³ / ₄	28- ¹ / ₄ x 15 x 15- ¹ / ₂	27- ⁷ / ₈ x 14- ⁷ / ₈	4- ⁵ / ₈	2- ⁵ / ₁₆	6,568	514 lbs.	ESL10
BFS3416E1	39- ¹ / ₈ x 21 x 23- ³ / ₄	34- ¹ / ₂ x 16- ³ / ₈ x 16- ³ / ₄	33- ⁷ / ₈ x 15- ⁵ / ₈	4- ⁵ / ₈	2- ⁵ / ₁₆	9,462	634 lbs.	ESL10
BFS5420E1	49- ⁷ / ₈ x 25- ¹ / ₈ x 25- ³ / ₄	44- ⁷ / ₈ x 20- ¹ / ₈ x 18- ¹ / ₂	44-9/16 x 19- ³ / ₄	4- ⁵ / ₈	2- ⁵ / ₁₆	16,707	792 lbs.	ESL10

NOTE: BFS5420E1 available March 2023

BFS912E5LP U.L. & ETL CERTIFIED BURGLARY & FIRE SAFE



BFS912E5LP



The BFS912E5LP combines burglary and fire protection in a compact safe.

RATINGS:

- ETL verified fire protection of 1775° F for 60 minutes
- U.L. residential security container (RSC) burglary classification

BODY

- 1-³/₄" double wall steel construction
- 3/16" steel barrier
- Unique fire resistant barrier
- Interlock fire-safe jamb
- Two anchor holes with hardware

DOOR

- Unique fire resistant barrier
- ESL5LP, U.L. type 1 high security electronic lock
- Massive hardplate and two relock devices
- Three ³/₈" x 1" steel locking bolts
- Three ³/₈" x 1" steel dead bolts

COLOR(S): Durable and attractive black body with gray door.

Model	Outside Dimension H" x W" x D"	Inside Dimension H" x W" x D"	Door Clearance H" x W"	Door Thickness	Body Thickness	Cubic Capacity	Weight	Lock Type
BFS912E5LP	12- ³ / ₄ x 16- ¹ / ₄ x 16- ³ / ₈	9 x 12- ¹ / ₂ x 11	8- ⁷ / ₈ x 12- ¹ / ₂	3	1- ³ / ₄	1,238	145 lbs.	ESL5 LP

AM SERIES HOME SECURITY SAFES



FEATURES:

- Powder-coated blue with black nickel hardware
- Gray fabric interior
- Backlit U.L. Listed ESL5 electronic lock
- 12-gauge steel body
- Drywall lined
- 45-Minute ETL Fire Rating at 1200°F
- Three-way bolt work
- 4 pre-cut anchor holes
- AM2020E5: one shelf, AM3020E5: 2 shelves, AM4020E5: 3 shelves

Optional 8" LED light kit with motion sensor available for all models. See page 12 for details.



AM2020E5



AM3020E5



AM4020E5

Model	Outside Dimension H" x W" x D"	Inside Dimension H" x W" x D"	Door Clearance H" x W"	Door Thickness	Body Thickness	Cubic Capacity	Weight	Lock Type
AM2020E5	20 x 20 x 20	17-¼ x 17-¼ x 14	14-½ x 14-½	1-½	12 GA	4,166	180 lbs.	ESL 5
AM3020E5	30 x 20 x 20	27-¼ x 17-¼ x 14	24-½ x 14-½	1-½	12 GA	6,581	230 lbs.	ESL 5
AM4020E5	40 x 20 x 20	37-¼ x 17-¼ x 14	34-½ x 14-½	1-½	12 GA	8,996	316 lbs.	ESL 5

COMMERCIAL SECURITY SAFES

CSC SERIES COMPOSITE SAFES



American Security CSC SERIES COMPOSITE SAFES are an affordable solution when you want to protect both documents from fire and valuables from burglary attacks. During extreme testing procedures the CSC SERIES COMPOSITE safes passed a 2-Hour, 350°F internal and 1700°F external factory fire test certification. UL listed RSC Level I.

DOOR FEATURES

- Overall thickness of 4-5/8" and is constructed with a 2" defense barrier of outer and inner steel plates creating a burglary resistant structure enclosing a unique proprietary, fire resistant material

BODY FEATURES

- 2-7/8" double wall steel construction enclosing a unique, high-density fire and burglary resistant composite material
- Durable powder coated adjustable shelves
- Fire Endurance: 2 hour, 350°F factory fire rating.
- Heat expandable intumescent door seal guards contents against severe fires

LOCKING MECHANISM FEATURES

- Two to four 1-1/2" diameter solid steel chrome-plated locking bolts
- Two to three 1-1/2" diameter solid steel dead bolts lock deep into body preventing door removal during a forced entry attempt
- U.L. Listed ESL10 or Group II combination lock with chrome-plated spy-proof dial. Optional electronic locks available
- Lock protected by a tempered glass relock device
- Heavy duty steel hinges provide easy, smooth door operation
- One internal counter-sunk anchor hole and mounting hardware are provided to securely anchor safe
- Attractively accented with a full width fascia panel and matching three point handle
- Durable and attractive charcoal gray textured finish

Optional Stor-It cabinets available in models CSC3018 and CSC4520. No kit needed, drawers slide right in.

Optional 8" LED light kit with motion sensor available for all models. See page 10 for details.



CSC4520



CSC1413



CSC1913



CSC3018

Model	Outside Dimension H" x W" x D"	Inside Dimension H" x W" x D"	Door Clearance H" x W"	Door Thickness	Body Thickness	Cubic Capacity	Weight	Lock Type
CSC1413	19-1/2 x 18 x 19-7/8	14 x 12-1/2 x 12-1/4	14 x 12-1/2	2	2-3/4	2,135	256 lbs.	Spy-proof dial, ESL10
CSC1913	24-1/2 x 18 x 19-7/8	19 x 12-3/8 x 12	19 x 12-3/8	2	2-3/4	2,898	318 lbs.	Spy-proof dial, ESL10
CSC3018	35-1/2 x 23-1/2 x 24	30 x 18 x 16-1/2	30 x 18	2	2-3/4	8,802	496 lbs.	Spy-proof dial, ESL10
CSC4520	50-1/2 x 25-1/2 x 28-7/8	45 x 20 x 21-1/4	45 x 20	2	2-3/4	19,080	728 lbs.	Spy-proof dial, ESL10

Add 2" to outside depth for handle, dial and hinge projection. Add 4/4" (casters) and 1" (rubber feet) to outside height.

ELECTRONIC SECURITY SAFES

EST SERIES HOME SECURITY SAFES

FEATURES

- DL6000 bounce-proof electronic lock with a large LCD display allows smooth and easy operation
- LCD display shows low-battery indicator, time, date and keypad
- Emergency key-lock override system with two (2) keys, power override battery box,

- built-in spy-proof function and motion detector alert
- Heavy 14 gauge solid steel construction, plus dual live bolts made also of heavy gauge steel
- Can be bolted to the wall or floor
- Carpeted base

- Pry-resistant recessed door with internal hinges for anti-theft protection
- Anchor hardware standard
- Models EST1014 and EST2014 have one removable shelf



EST813



EST916



EST1014



EST2014

Model	Outside Dimension H" x W" x D"	Inside Dimension H" x W" x D"	Door Clearance H" x W"	Door Thickness	Body Thickness	Cubic Capacity	Weight	Lock Type
EST813	7-7/8 x 12-1/4 x 8	7-11/16 x 12-1/16 x 5-3/8	5-3/4 x 8-1/4	5 mm	14 GA	499	16 lbs.	DL6000
EST916	9 x 16 x 13-1/4	8-3/16 x 15-3/16 x 11-1/8	6-3/4 x 12-1/8	5 mm	14 GA	1,550	27 lbs.	DL6000
EST1014	9-3/4 x 14-1/8 x 9-3/4	9-9/16 x 13-15/16 x 7-3/4	7-5/8 x 10-1/4	5 mm	14 GA	1,032	22 lbs.	DL6000
EST2014	19-3/4 x 13-3/4 x 12-1/4	19-9/16 x 13-9/16 x 10	17-1/8 x 9-1/4	5 mm	14 GA	2,602	40 lbs.	DL6000

IRC916 IN-ROOM ELECTRONIC SAFE



IRC916E

American Security's IN-ROOM ELECTRONIC SAFE, with its easy installation, maintenance and management features has become a popular safe in the hospitality industry. Designed with the traveling guests in mind, the IRC916E will adequately secure laptop computers, cameras, jewelry and other valuables in the most user-friendly safe made.

FEATURES:

- Heavy duty steel construction offers excellent burglary protection
- Convenient motorized locking system, incorporating the latest technology
- Easy to read, large LED display lets you know the status of the safe
- 4 to 6 digit combination, standard hotel room configuration (customer sets new combination every time safe is used, quickly and easily), or electronic credit card
- Reliable ADA approved keypad
- Runs on 4 AA batteries. If batteries should go dead, each safe has a by-pass power cable
- Lock-out penalty if the combination is entered wrong, the safe will lock up for 15 minutes, frustrating the would-be burglar.

- Emergency key-lock override system with 2 keys
- Spacious interior fits most lap top computers
- Two anchor holes with mounting hardware included
- Attractive carpeted bottom hides anchor bolts
- Electrostatic powder-coated finish in textured black
- Guest instruction label included
- Packaged for UPS shipment

OPTIONS:

- Hand-held, programming device, offering audit trail and electronic override (IRCPROG)

Model	Outside Dimension H" x W" x D"	Inside Dimension H" x W" x D"	Door Clearance H" x W"	Door Thickness	Body Thickness	Cubic Capacity	Weight	Lock Type
IRC916E	9 x 16 x 14	8-3/16 x 15-3/16 x 12	6-3/16 x 13	5 mm	14 GA	1,672	29 lbs.	4 to 6 Digit Combination or Electronic Credit Card Reader

U.L. LISTED 2-HOUR FIRE AND IMPACT SAFES



FEATURES

- The best warranty in the business. Lifetime fire replacement and one year parts and labor
- U.L. listed Class 350°F two hour fire and impact rating
- Safes withstand fires of up to 1850°F for two hours and a 30' drop – equivalent to falling through a 2 story burning building
- Increased barriers for burglary protection. Impressive 3-½" thick recessed door with ⅝" thick front for excellent pry resistance
- Handle activated locking mechanism with ⅞" diameter solid steel chrome plated locking bolts offering smooth operation
- Internal anchor bolt hole with hardware

- U.L. listed Group II key changeable combination lock with relock. 1 million possible combinations
- Auxiliary spring-loaded relock device activated by severe attack
- Heavy duty steel hinges provide additional security and smooth operation
- For your convenience, rubber feet are standard
- One adjustable shelf and one base on all models
- Attractively accented with a brass or chrome handle, decorative emblems and plush velour interior
- Available in durable Granite or Sandstone textured finishes

COLOR(S):

Charcoal gray

Hardware colors:

Chrome (LTE), Brass (LTG)

* Add 2" for handle, dial and hinge projection. Outside height includes 1" high rubber feet on models U.L.1511-U.L.1812XD

U.L. Safes Lifetime Replacement Warranty:

All American Security U.L. Listed fire safes are protected by a LIFETIME FREE REPLACEMENT GUARANTEE, assuring the original owner free replacement of safes that are damaged beyond repair by a fire with a current production model of comparable value. The damaged safe must be returned freight prepaid to the factory within 30 days of the loss, accompanied by a properly filed fire department report.



UL1511



UL1812

Model	Outside Dimension H" x W" x D"	Inside Dimension H" x W" x D"	Door Clearance H" x W"	Door Thickness	Body Thickness	Cubic Capacity	Weight	Lock Type
UL1511	21 x 17 x 18-½	15-¼ x 11 x 12	15-¼ x 11	3-½	2-¾	2,139	246 lbs.	U.L. listed Group II
UL1812	25 x 18 x 18-½	18-½ x 12-½ x 12	18-½ x 12-½	3-½	2-¾	2,775	272 lbs.	U.L. listed Group II
UL1812X	25 x 18 x 23-½	18-½ x 12-½ x 17	18-½ x 12-½	3-½	2-¾	3,931	298 lbs.	U.L. listed Group II

* Add 2" for handle, dial and hinge projection. Outside height includes 1" high rubber feet on models UL1511-UL1812XD; 2¾" for casters on the two largest models.

* Shown with optional electronic lock

FS SERIES IMPORTED U.L. LISTED 1-HOUR FIRE SAFES



The economical range of our IMPORTED RESIDENTIAL FIRE SAFES are the answer's to today's high incidence of residential fires. Our Fire Safes also provide burglary protection making them ideal for home and light commercial applications.

MODELS FS914E5LP AND FS149E5LP

- U.L. Listed 350°F 1-Hour fire rating
- U.L. Listed ESL5LP E-lock
- One (1) drawer shelf
- Handle operated side-locking mechanism with two chromed locking bolts
- Two deadbolts prevent door removal
- Four (4) rubber feet
- One (1) internal anchor hole and hardware
- Attractive black granite finish

MODEL FS1814E5

- U.L. Listed 350°F 1-Hour fire rating
- U.L. Listed ESL5 E-lock
- Handle operated locking mechanism with three-way boltwork
- Two deadbolts prevent door removal
- One (1) key-lock drawer and one adjustable shelf
- One (1) internal anchor hole and hardware,
- Attractive black granite finish

Optional 8" LED light kit with motion sensor available for all models. See page 10 for details.

American Security's FS Series is the only 1 hour economical fire safe with a high-security electronic lock.

American Security



Other Brands





FS914E5LP



FS149E5LP



FS1814E5

Model	Outside Dimension H" x W" x D"	Inside Dimension H" x W" x D"	Door Clearance H" x W"	Door Thickness	Body Thickness	Cubic Capacity	Weight	Lock Type
FS914E5LP	14 x 19-1/2 x 15-3/8	9-3/4 x 15-1/4 x 9-7/8	9-3/4 x 15-1/4	3	2-1/8	1,438	96 lbs.	ESL5LP
FS149E5LP	19-1/2 x 14 x 15-3/8	15-1/4 x 9-3/4 x 9-7/8	15-1/4 x 9-3/4	3	2-1/8	1,468	96 lbs.	ESL5LP
FS1814E5	23-3/4 x 18-7/8 x 18-1/2	18-1/4 x 13-1/8 x 12-3/8	18-1/4 x 13-1/8	4	2-3/4	2,964	164 lbs.	ESL5

*Add 2" for handle, dial and hinge projection. Model FS1814E5 has one key-lock drawer and one adjustable shelf. Dimensions have been converted from metric measurements. Please allow +1/4" to -1/4" variation for both outer and inner dimensions listed

FLOOR SAFES

SUPER BRUTE



ALL SUPER BRUTE SERIES safes are designed to provide secure storage for documents, jewelry, precious metals and miscellaneous valuables at an economical price. When properly installed in a concrete floor, SUPER BRUTE SERIES safes provide excellent fire and burglary protection. SUPER BRUTE floor safes meet and exceed the requirements of the Insurance Offices Manual of Burglary Insurance.

STANDARD FEATURES

- Charcoal Gray textured body and door
- Attractive design offers strong reliable welds to protect against burglary attacks and reduce possible leakage
- U.L.-listed Group II combination lock
- An additional spring-loaded reloading device, activated by a punching attack
- Lock and relocks are protected by a large carburized hardplate
- Handle activated locking mechanism consisting of three 1" diameter locking bolts. Each bolt is drive resistant, chromed steel with a long throw

- One piece heavy duty dead bar behind hinge prevents removal of door even if hinges are removed during a forced entry attempt

BODY

- Oversize floor plate ensures strong installation in concrete
- Flush cover plate
- Solid steel hinge mechanism using 3/8" diameter steel hinge pins and internal mounting bolts
- Door jamb design is manufactured with state-of-the-art equipment, with built-in devices offering the ultimate protection against sledgehammer attack
- Doors are removable and interchangeable
- One sliding shelf with double wide model (B3700)
- Attractive carpeted floor in every unit

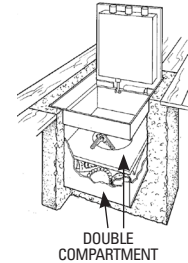

B3700



B2900



B1500



B2200

Super Brute Floor Safes Lifetime Replacement Warranty:

For more information visit our website at: <https://americansecuritysafes.com/warranty/>

Model	Outside Dimension H" x W" x D"	Inside Dimension H" x W" x D"	Door Clearance H" x W"	Door Thickness	Body Thickness	Cubic Capacity	Weight	Lock Type
B1500*	12-3/4 x 14-1/8 x 11-3/4	12-1/4 x 13-5/8 x 8-3/4	10-3/4 x 11-1/8	3/4	4 GA	1,377	102 lbs.	Combo Lock
B2200*	12-3/4 x 14-1/8 x 17	12-1/4 x 13-5/8 x 13-15/16	10-3/4 x 11-1/8	3/4	4 GA	2,203	118 lbs.	Combo Lock
B2900*	12-3/4 x 14-1/8 x 21-3/8	12-1/4 x 13-5/8 x 18-5/16	10-3/4 x 11-1/8	3/4	4 GA	2,872	134 lbs.	Combo Lock
B3700*	12-3/4 x 24 x 16-3/4	11-7/8 x 23-3/8 x 13-5/8	10-3/4 x 11-1/8	3/4	7 GA	3,785	145 lbs.	Combo Lock
B5800*	12-3/4 x 36 x 16-3/4	11-7/8 x 35 x 13-5/8	10-3/4 x 11-1/8	3/4	7 GA	5,758	185 lbs.	Combo Lock

*Constructed of 3/4" door and B-Rate body.

FLOOR SAFES

STAR® ROUND LIFT-OUT DOOR

STAR SAFE® FLOOR SAFES are engineered with advanced security features. STAR Tube safes have been the standard for gas stations, fast food, small retail establishments and home owners for over 70 years.

FEATURES

- Manipulation resistant, unitized key changeable lock protected by a revolving carburized hardplate
- Removable dial and drive/drill resistant spindle preventing damage from burglary attack and additional protection from hold-up

- Door, 7-¼" clear opening, is 1-¾" solid steel
- Door is securely locked by three bolts each requiring over 25,000 pounds to shear
- Each locking bolt has its own hardened steel positive relocking bolt

- Body — Heavy "B" rate construction
- Water resistant, high impact molded dust cover with rubber "O"-ring seal does not rattle or slide like most covers

Note: Safes with slotted doors are not recommended for overnight storage.



Model	Outside Dimension H" x W" x D"	Inside Dimension H" x W" x D"	Door Clearance H" x W"	Door Thickness"	Body Thickness"	Cubic Capacity	Weight	Lock Type
C3 / K3 †	8-¾ DIA x 9	8-¼ DIA x 5-¾	7-¼ DIA	1-¾	7 GA	280	40 lbs.	Combination Lock, Key Lock
C5 / K5 †	8-¾ DIA x 13-½	8-¼ DIA x 10	7-¼ DIA	1-¾	7 GA	510	48 lbs.	Combination Lock, Key Lock
C7 / K7 †	8-¾ DIA x 19	8-¼ DIA x 16	7-¼ DIA	1-¾	7 GA	785	55 lbs.	Combination Lock, Key Lock

† (K) = Key lock door

STAR® RECTANGULAR BODY, ROUND LIFT-OUT DOOR

Star Safe® Rectangular Body, Round Lift-out Door "B" RATE FLOOR SAFES offer a large cubic inch capacity at a reasonable price. Strong, continuously welded steel bodies are offered with our standard "C" rate lift-out combination door and water-resistant dust cover.

FEATURES:

- Utilizes the STAR high security "C" rate door



When properly installed in concrete, STAR® Floor Safes provide excellent fire and burglary protection. Now, with the water resistant dust cover, you get protection from water as well.

Model	Outside Dimension H" x W" x D"	Inside Dimension H" x W" x D"	Door Clearance H" x W"	Door Thickness	Body Thickness	Cubic Capacity	Weight	Lock Type
B17	13 x 13 x 15	12 x 12-½ x 10	7-¼ DIA	1-¾	4 GA	1,500	98 lbs.	Combination Lock, Key Lock
B24	13 x 13 x 19	12 x 12-½ x 14-½	7-¼ DIA	1-¾	4 GA	2,175	122 lbs.	Combination Lock, Key Lock

WALL SAFES

American Security WALL SAFES are designed to provide hidden protection for documents and miscellaneous valuables. Each wall safe is also designed for easy installation between 16" o/c wall studs. Pre-drilled anchor holes and a built-in flange eliminates unnecessary replastering.

WEST 2114 FEATURES

- Extra spacious interior, while still offering the convenience of fitting between studs
- DL6000 bounce-proof electronic lock with a LCD display allows smooth and easy operation
- LCD display shows low-battery indicator, time, date and keypad
- Emergency key-lock override system with two (2) keys, power override battery box, built-in spy-proof function and motion detector alert
- Heavy gauge solid steel construction, plus dual live bolts made also of heavy gauge steel

- Carpeted base
- Pry-resistant recessed door with internal hinges for anti-theft protection
- Two removable shelves
- Cream colored, durable powder coated finish
- Packaged for UPS shipment

HEAVY-DUTY WS1214E5 FEATURES

- An additional spring-loaded reloading device, activated by a punching attack
- Lock and relocks are protected by a large carburized hardplate
- Handle activated locking mechanism consisting of three 1" diameter locking bolts. Each bolt is drive resistant, chromed steel with a long throw
- One piece heavy duty dead bar behind hinge prevents removal of door even if hinges are removed during a forced entry attempt
- Two removable shelves. Extra deep interior
- American Security's U.L.- Listed ESL5 electronic lock

HEAVY-DUTY WFS149E5LP FEATURES

- U.L. Listed one hour fire rating, ensuring the inside temperature never exceeded 350° F (paper chars at 450° F)
- Extra deep interior, with one (1) convenient drawer shelf
- American Security's U.L.-Listed ESL5 electronic lock
- Each safe is equipped with side locking boltwork mechanism incorporating ½" steel deadbolts
- Impressive ½" thick door with attractive Black Granite finish



WFS149E5LP



WS1214E5



WEST2114

Model	Outside Dimension H" x W" x D"	Inside Dimension H" x W" x D"	Door Clearance H" x W"	Door Thickness	Body Thickness	Cubic Capacity	Weight	Lock Type
WFS149E5LP*	19-½ x 14 x 15-¾	15-¼ x 9-¾ x 9-¾	15-¼ x 9-¾	3	2-½	1,468	104 lbs.	ESL5LP
WS1214E5	12-5/8 x 14 x 10	12-¼ x 13-5/8 x 5-¼	10-¾ x 11-¼	¾	7 GA	876	86 lbs.	ESL5
WEST2114	21-½ x 13-7/8 x 4	20-7/8 x 13-¾ x 2-7/8	19-¼ x 10-¼	7 GA	14 GA	733	31 lbs.	DL6000

* 350° F, U.L. Listed, 1-Hr fire rated wall safe.

UNDERCOUNTER SAFES

UNDERCOUNTER SAFES

American Security's UNDERCOUNTER SAFES limit excess cash register funds by providing instant protection for interim deposits of cash or checks via the anti-fish deposit slot. Securely positioning the safe next to the cash register limits exposed cash and reduces the threat of robbery and internal theft. Adaptable for multiunit installation use, ideal for gun control, staff use, athletics clubs, security areas and much more..

FEATURES

- Heavy gauge solid steel construction
- Full width deposit slot over door equipped with an "anti-fish" saw tooth baffle to guard against pilferage or fishing
- Heavy-duty piano hinges
- Available with six different lock options to fit your specialized security requirements
- Units can be bolted together utilizing bolt holes
- Interchangeable doors allow flexible means of changing locking mechanisms without replacing the entire unit
- Two anchor holes provided on all four sides
- Attractive and durable powder coated black finish

LOCK OPTIONS

- Single key camlock equipped with two keys. (Lock option -1)
- Chicago 7 pin radial key camlock, equipped with 2 keys. (Lock option 1T)
- Medeco® U.L. listed high security single key camlock supplied with two keys. Medeco's restricted keyways protect against unauthorized key duplication. (Lock option-2)
- Dual custody safe deposit key lock (two keys required to open safe). (Lock option -4)
- Best removable core key lock supplied without core. A removable core system lets you change the combination of any lock in seconds and can easily expand to include new facilities. Supplied without core. (Lock option -7, without core)
- Optional custom key control systems designed to your security requirements:
 1. Master Keyed
 2. Keyed Alike
 3. Keyed Different

HEAVY-DUTY SERIES MODEL K1

- Full width slot over door
- A saw tooth baffle guards against pilferage or fishing
- Your choice of a single key Medeco® lock (K-1), or a Chicago single key lock (K-1A)
- "B" Rate steel construction
- May be installed vertically or horizontally
- May be mounted on or under counter as space permits
- Durable, impact resistant Black textured finish

IMPORTANT:

American Security Undercounter safes are recommended for an operation that requires a non-returnable deposit. These safes are not meant for overnight storage of cash



(LOCK OPTION-2) TB0610-2
Medeco® Single Key Camlock



(LOCK OPTION -7) TB0610-7
Best removable core key lock
(core not included)



K1



LOCK OPTION -1) TB0610-1T
Single key camlock

Model	Outside Dimension H" x W" x D"	Inside Dimension H" x W" x D"	Door Clearance H" x W"	Door Thickness	Body Thickness	Cubic Capacity	Weight	Lock Type
TB0610	6 x 6 x 10	5-7/8 x 5-7/8 x 8-3/8	5-7/8 x 5	14 GA	14 GA	289	8 lbs.	Chicago 7-Pin Radial Key Camlock
K1	6 x 6 x 12	5-5/8 x 5-5/8 x 10-5/8	3-3/16 x 5	4 GA	9 GA	337	16 lbs.	Medeco Single- Key Lock

NOTE: Models TB0610 is available with the American Security ESL Slam lock. (Factory installed primary lock.)

DEPOSITORY SAFES

DS SERIES "B" RATE ROTARY & FRONT LOADING

American Security's DS Series Depository Safes are designed to provide immediate deposits and storage for cash, jewelry and miscellaneous valuables.

Deposits can be made to a locked compartment via a top-loading rotary hopper, a reverse or a front-loading deposit door.



DST2014



DSF2014



DSF2714



DSF3214

BODY

- Strong, formed "B" Rate construction made of A36 solid steel plate for improved security and appearance
- Formed door jamb for increased resistance to sledgehammer attack
- Four anchor bolt holes are standard

DOOR MODEL NUMBERS: 2014, 2714 & 3214

- ½" thick A36 solid steel plate, recessed ½" to increase resistance to pry attack
- Three 1" diameter chromed steel locking bolts
- Bolt detent system engages boltwork automatically
- Auxiliary spring-loaded relocking device
- Lock and relock protected by large carburized hardplate

HOPPER

- Large package sizes:
(Top Load Rotary): 4-¾"D x 4-¾"W x 10"L
(Front/Reverse Load): 4"D x 2-¾"W x 10-½"L
- Recessed, heavy duty ¾" construction (¼" door)
- Protected by dual "anti-fish" baffle

COLOR(S): Charcoal Gray

Model	Outside Dimension H" x W" x D"	Inside Dimension H" x W" x D"	Door Clearance H" x W"	Door Thickness	Body Thickness	Cubic Capacity	Weight	Lock Type
DST2014	20-¼ x 14 x 14	11-½ x 13-¾ x 11	9-¾ x 9-¾	½	11 GA	1,739	90 lbs.	ESL10
DSF2014	20-¼ x 14 x 14	10 x 13-¾ x 11	9-¾ x 9-¾	½	11 GA	1,513	79 lbs.	ESL10
DSF2714	27-¼ x 14 x 14	17-¼ x 13-¾ x 11	9-¾ x 9-¾	½	11 GA	2,609	93 lbs.	ESL10
DSF3214	32-¼ x 14 x 14	TP 11-¼ x 13-¾ x 11 BT 12-½ x 13-¾ x 11	9-¾ x 9-¾	½	11 GA	1,815 1,702	144 lbs.	ESL10

†Specify Prefix: T=Top Loading, F=Front Loading *Add 2" to outside depth for dial and handle projection.

DEPOSITORY SAFES

DS SERIES TILL STORAGE DEPOSITORY SAFES

BODY

- Four anchor bolt holes

DOOR

- Three 1" dia. steel locking bolts
- Auto lock bolt detent system
- Internal relocking device
- Large carburized hardplate



DSF2516E2



DSR2516E2

INTERIOR

Receiving locker:

1. ¼" solid steel plate with cam key lock
2. Clear door: 6"H x 10"W
3. ID: 5 7/8"H x 15 3/4"W x 13 3/4"D
4. Cubic capacity: 1272 cu/in

Till Storage Compartment

1. Fit up to 4 till trays
2. Clear door: 14½" h x 12" w
3. Inside Dimensions: 9"h x 15 3/4"w x 17"d
4. Cubic capacity: 2410 cu/in

FRONT HOPPER

- Large package sizes: 4"D x 2¾"W x 10½"L
- ¼" solid steel plate
- Dual "anti-fish" baffles

REVERSE HOPPER

- Large package sizes: 4"D x 2½"W x 9½"L
- ½" solid steel plate with cam key lock
- Protected by dual "anti-fish" baffles
- Thru the wall depository with adjustable chute
- Wall Thickness: 6 7/8" to 13 7/8"
- Floor Height: 36 ¾" to 48 ¾"

COLOR(S): Textured charcoal gray

Model	Outside Dimension H" x W" x D"	Inside Dimension H" x W" x D"	Door Clearance H" x W"	Door Thickness	Body Thickness	Cubic Capacity	Weight	Lock Type
DSF2516E2	25 x 16 x 20	24-¾ x 15-¾ x 17	14-½ x 12	½	11 GA	3,682	170 lbs.	ESL20
DSR2516E2	25 x 16 x 20	24-¾ x 15-¾ x 17	14-½ x 12	½	11 GA	3,682	260 lbs.	ESL20

MONEY MANAGER SERIES



THREE-DROP



TOP-DROP



CENTER-DROP

**WHILE SUPPLIES
LAST**

American Security's "B" Rate Money Manager Series Undercounter Two Door Depository Safes are the most effective cash handling systems available. Engineered to help you achieve total cash control.

STANDARD FEATURES:

- Three drop offers three color-coded drops and bins
- Three 1" diameter locking bolts
- Auto lock bolt detent
- Internal relock device
- Large carburized hardplate

- Coin racks
- Front hopper: 16¼"W x 2"H x 3½"D
- Front hopper features "anti-fish" baffles
- Four anchor bolts with hardware
- 3 models: 3-drop, Top-Drop, and CTR Drop

COLOR(S): Charcoal Gray

Model	Outside Dimension H" x W" x D"	Inside Dimension H" x W" x D"	Door Clearance H" x W"	Door Thickness	Body Thickness	Cubic Capacity	Weight	Lock Type
MM28203-Drop-ESLAudit	28 x 20-½ x 20	TOP 9-½ x 20 x 17 BTM 11 x 20 x 17	8-½ x 16-¼ 8-½ x 16-¼	½	11 GA	3,230 3,740	247 lbs.	ESLAudit II
MM28203Top-Drop-ESLAudit	28 x 20-½ x 20	TOP 9-½ x 20 x 17 BTM 11 x 20 x 17	8-½ x 16-¼ 8-½ x 16-¼	½	11 GA	3,230 3,740	274 lbs.	ESLAudit II
MM2820Ctr-Drop-ESLAudit	28 x 20-½ x 20	TOP 10-¾ x 20 x 17 BTM 10-¾ x 20 x 17	8-½ x 16-¼ 8-½ x 16-¼	½	11 GA	3,230 3,740	278 lbs.	ESLAudit II

DEPOSITORY SAFES

RETAIL MONEY MANAGER SAFES

American Security's RETAIL MONEY MANAGER SAFE offers unrivaled value in electronic safe access. Built tough to maximize protection against burglary attempts, the Retail Money Manager has all the advanced features necessary for commercial applications.

SAFE FEATURES:

- Solid steel 1/2" thick door equipped with 10 solid steel Anti-Spread Pins



RMM2620ESL20-R, shown with optional base

- Formed high tensile steel body and jamb construction to maximize protection against pry attack
- Provided with 6 removable door mounted coin racks
- Reinforced internal jambs on all four sides provide protection against sledgehammer attack
- 3-way locking system with five 1" dia Chrome plated locking bolts
- Bolt detent system engages boltwork and locks the door automatically
- Auxiliary spring-loaded relocking devices
- Locks and relocks protected by a large carburized hardplate
- Standard Four (4) anchor bolt holes
- Left-Swing door available

INTERIOR LOCK FEATURES:

- Heavy 1/4" steel door, 9-1/4" H x 19-3/4" W x 13-1/2" (12-7/8" Clear) D
- Large clear door opening: 6-9/16" H x 14" W
- Locker door closes when outer door is closed

DEPOSIT DRAWER FEATURES:

- Large "fish" and "pry" resistant solid steel deposit drawer deposits
- Drawer size: 2" x 4-1/4" x 9-1/2"

LOCK FEATURES:

- The Retail Money Manager Safe is available with either the American Security SafeWizardII® Electronic lock, American Security ESLAudit II Electronic Lock or the American Security ESL20 Electronic Lock

Model	Outside Dimension H" x W" x D"	Inside Dimension H" x W" x D"	Door Clearance H" x W"	Door Thickness	Body Thickness	Interior Capacity	Weight	Lock Type
RMM2620SW-R	26 x 20 x 18-1/2	25-3/4 x 19-3/4 x 15-5/8	18-1/4 x 15-1/2	1/2	1/8	7946	280 lbs.	SafeWizard II
RMM2620ESLAudit II-R	26 x 20 x 18-1/2	25-3/4 x 19-3/4 x 15-5/8	18-1/4 x 15-1/2	1/2	1/8	7946	280 lbs.	ESLAudit II
RMM2620ESL20-R	26 x 20 x 18-1/2	25-3/4 x 19-3/4 x 15-5/8	18-1/4 x 15-1/2	1/2	1/8	7946	280 lbs.	ESL20



RMM3124ESLAudit II

RMM3124ESLAUDIT FEATURES:

- Extra large storage compartment for cash tills, cash box, cash bag and bulk coin
- Comes standard with 9 door mounted coin racks
- Extra large deposit compartment with anti fish rotary hopper
- LED light with motion sensor make it easy to see inside both the rotary hopper and deposit compartment

- 1/2" thick solid steel doors
- Formed high tensile steel body
- Both doors auto lock when closed
- Built-in alarm contacts on both doors
- Four anchor bolt holes
- ESLAudit II lock

Model	Outside Dimension H" x W" x D"	Inside Dimension H" x W" x D"	Door Clearance H" x W"	Door Thickness	Body Thickness	Interior Capacity	Weight	Lock Type
RMM3124ESLAudit II	31 x 24-1/2 x 20	Left: 30-3/4 x 15-3/8 x 17-3/8 Right: 24-1/2 x 8-3/4 x 17-3/8	Left: 28 x 13-1/2 Right: 12-5/8 x 5-3/4	1/2	11 GA	Left: 8220 Right: 3726	360 lbs.	ESLAudit II

DEPOSITORY SAFES

BWB SERIES - WIDE BODY CASH CONTROL

Extensive research and development went into the engineering of American Security's WIDE BODY "B" RATE CASH HANDLING DEPOSITORY SAFES.

Designed to offer complete cash management versatility with a front load depository option or a pull-out deposit drawer (Model BWB3020D1).

BWB STANDARD FEATURES

- Formed high tensile steel body and jamb construction to maximize protection against pry attack
- Reinforced internal jambs on all four sides to provide protection against sledgehammer attack
- 3-way locking mechanism consisting of five 1" diameter chromed steel locking bolts
- Bolt detent system engages boltwork automatically
- Locks and relocks protected by a large carburized hardplate
- Auxiliary spring-loaded relocking devices
- Convenient, door-mounted, recessed coin rack
- Standard Four (4) anchor bolt holes



BWB2020FLNL

INTERIOR LOCKER FEATURES

- Heavy ¼" steel door, and single-key camlock with two keys
- Large clear door opening: – 6" H x 12"W (for 20" W safes) or
- Inside Dimensions: BWB2020/BWB3020/BWB4020: 8⅝" x 19¼" x 14"
- Note: Front Load Depository - inside locker height restricted to 6"

DEPOSIT DRAWER FEATURES (ONLY MODEL BWB3020D1)

- Large "fish" resistant, pull out drop drawer deposits directly into standard interior locker
- Drawer size: 1⅞" x 3½" x 7½"
- Heavy duty steel sliding drawer

FRONT LOAD DEPOSITORY FEATURES

- Recessed heavy duty ⅝" construction with ⅝" door



BWB4020FL

- Protected by dual "anti-fish baffles"
- Large package capacity: 4' x 9' x 11½" (maximum)
- May be ordered in any one of four directions Specify front, reversed, right load or left load

EACH UNIT COMES EQUIPPED WITH AN INTERIOR LOCKER TO ACCOMMODATE DEPOSITS, A LARGE INTERIOR FOR STORAGE OF CASH TRAYS AND BULK COIN, EXCEPT 2020FLNL.

IMPORTANT:

American Security depository safes are recommended for an operation that requires a non-returnable deposit such as armored car companies, convenience stores, restaurants, etc. The top locker is not meant for overnight storage of cash or valuables.



BWB3020D1

Model	Outside Dimension H" x W" x D"	Inside Dimension H" x W" x D"	Door Clearance H" x W"	Door Thickness	Body Thickness	Cubic Capacity	Weight	Lock Type
BWB2020FL	29-¾ x 20 x 20	9 x 19-¾ x 17	14-¾ x 16-¼	½	11 GA	3,022 in.	218 lbs.	ESL10
BWB2020FLNL	29-¾ x 20 x 20	19-¾ x 19-¾ x 17	14-¾ x 16-¼	½	11 GA	6,630 in.	200 lbs.	ESL10
BWB3020FL	39-¾ x 20 x 20	19 x 19-¾ x 17	24-¾ x 16-¼	½	11 GA	6,380 in.	278 lbs.	ESL10
BWB4020FL	49-¾ x 20 x 20	29 x 19-¾ x 17	34-¾ x 16-¼	½	11 GA	9,737 in.	360 lbs.	ESL10
BWB3020-D1	30 x 20 x 20	19-¾ x 19-¾ x 17	24-¾ x 16-¼	½	11 GA	6,380 in.	270 lbs.	ESL10

Add 2" to outside dimension for handle, dial and hinge projection.

"B" RATE SECURITY CHESTS

BWB SERIES AND MS1414

The many different features of the WIDE BODY SAFES, make them perfect for commercial application or home use.

STANDARD FEATURES FOR BWB

- ½" thick solid steel door, recessed for resistance to pry attacks
- Formed, high-tensile steel body and jamb construction to maximize protection against pry attacks
- U.L. listed Group II key changeable combination lock with over 1 million possible combinations
- Optional electronic locks available
- Auxiliary spring-loaded relock device
- Locks and relocks protected by a large carburized hardplate
- Attractive Charcoal Gray textured finish
- Four anchor bolt holes

ADDITIONAL BWB SERIES FEATURES

- Reinforced internal jambs on all four sides to provide excellent protection against sledgehammer attack
- 3-way locking mechanism consisting of five massive 1" diameter chromed steel locking bolts
- Bolt detent system keeps bolts retracted when the door is open, then automatically engages when door is shut
- Convenient door mounted recessed coin rack
- Large capacity for storage of cash trays
- Adjustable shelves

MINI SAFE (MS SERIES) FEATURES

- Formed, high-tensile steel body and jamb construction to maximize protection against pry attacks
- ½" solid steel door
- U.L. Group II combo lock (C)
- Three 1" diameter chromed steel locking bolts
- Bolt detent system engages boltwork automatically
- Auxiliary spring-loaded relocking device
- Lock and relock protected by large carburized hardplate
- Four anchor bolt holes
- Adjustable shelf provided
- Also available with optional deposit slot(s)
Slot size: ½" H x 6 W"



MS1414



BWB2020

Model	Outside Dimension H" x W" x D"	Inside Dimension H" x W" x D"	Door Clearance H" x W"	Door Thickness	Body Thickness	Cubic Capacity	Weight	Lock Type
BWB2020	20 x 20 x 20	19-¾ x 19-¾ x 17	13-¾ x 13-¾ x 11	½	11 GA	6,631 in.	154 lbs.	ESL10
BWB3020	30 x 20 x 20	29-¾ x 19-¾ x 17	24-¾ x 16-¼	½	11 GA	9,988 in.	218 lbs.	ESL10
BWB4020	40 x 20 x 20	39-¾ x 19-¾ x 17	34-¾ x 16-¼	½	11 GA	13,346 in.	272 lbs.	See pg. 52
MS1414	14 x 14 x 14	13-¾ x 13-¾ x 11	9-¾ x 9-¾	½	11 GA	2,080 in.	67 lbs.	Combo and ESL10

*Add 2" to outside depth for handle, dial and hinge projection.

*Add 2" for dial and hinge projection. † = 1 - 9/16" anchor hole with 1/2" anchor bolt kit standard on safes under 750 lbs.

"B" AND "C" RATE SECURITY CHESTS

BLB AND BLC SERIES



American Security "B" AND "C" RATE SECURITY CHESTS are designed to provide secure storage at an economical price. In addition to meeting the requirements of the Insurance Offices Manual of Burglary Insurance, these units offer an appearance and many features similar to American Security's higher rated TL-15 models.

DOOR FEATURES

- 1" ("C" Rate), or ½" ("B" Rate) steel pry resistant recessed door
- U.L. listed Group II key changeable lock, with relock and 1 million possible combinations
- Additional spring loaded relocking device, activated by a punching attack
- Locks and relocks protected by a large carburized hardplate
- A handle activated locking mechanism consisting of three 1" chromed steel locking bolts. (five in BLB and BLC4024 models)
- Solid steel full length dead bar prevents door removal if hinges are removed during a forced entry attempt
- Adjustable ball bearing hinges

BODY FEATURES

- ½" ("C" rate) or ¼" ("B" Rate) solid steel bodies
- Body reinforcing frame gives the appearance of 1" thick walls to discourage attack
- Adjustable shelves
- Custom sizes, interior options and high security features available
- Left swing door optional

COLOR(S): Charcoal Gray is the standard color. Other colors can be quoted upon request.



BLC3024



B-RATE PREMIUM FREE-STANDING SECURITY CHEST

Model	Outside Dimension H" x W" x D"	Inside Dimension H" x W" x D"	Door Clearance H" x W"	Door Thickness	Body Thickness	Cubic Capacity	Weight	Lock Type
BLB2018	20-½ x 18-½ x 15	20 x 18 x 12	18 x 16	½	4 GA	4,320 in.	218 lbs.	UL Group II
BLB3018	30-½ x 18-½ x 19	30 x 18 x 16	28 x 16	½	4 GA	8,640 in.	312 lbs.	UL Group II
BLB3024	30-½ x 24-½ x 23	30 x 24 x 20	28 x 22	½	4 GA	14,400 in.	360 lbs.	UL Group II
BLB4024	40-½ x 24-½ x 23	40 x 24 x 20	38 x 22	½	4 GA	19,200 in.	445 lbs.	UL Group II

*Add 2" to outside depth for handle, dial and hinge projection. Custom design available on request.

C-RATE PREMIUM FREE-STANDING SECURITY CHEST

Model	Outside Dimension H" x W" x D"	Inside Dimension H" x W" x D"	Door Clearance H" x W"	Door Thickness	Body Thickness	Cubic Capacity	Weight	Lock Type
BLC2018	21 x 19 x 16	20 x 18 x 12	18-½ x 16-½	1	½	4,320 in.	370 lbs.	UL Group II
BLC3018	31 x 19 x 20	30 x 18 x 16	28-½ x 16-½	1	½	8,640 in.	550 lbs.	UL Group II
BLC3024	31 x 25 x 24	30 x 24 x 20	28-½ x 22-½	1	½	14,400 in.	740 lbs.	UL Group II
BLC4024	41 x 25 x 24	40 x 24 x 20	38-½ x 22-½	1	½	19,200 in.	925 lbs.	UL Group II

*Add 2" to outside depth for handle, dial and hinge projection. Custom design available on request.

TL-15 MONEY CHESTS

DXE U.L. LISTED



American Security TL-15 U.L. Listed MONEY CHESTS qualify for Mercantile & Broadform Insurance Class ER (TL-15) with a banking rating of BR (TL-15). American Security MONEY CHESTS offer the highest level of security available with many outstanding features and a wide range of options.

DOOR FEATURES

- DXE model is TL-15 rated constructed of ½" thick high-strength solid steel plate
- Oil impregnated bronze bearing hinges

BODY FEATURES

- DXE models: Consist of ½" thick steel plate

(100,000 P.S.I. minimum tensile strength).

All external seams are beveled and continuously welded

- Shelf strips installed allowing shelf adjustment. Shelves optional

LOCKING MECHANISM FEATURES

- U.L. listed Group 2M key changeable combination lock, with relock and 1 million possible combinations
- Single auxiliary spring loaded reloading device, activated by a punching attack
- Locks and relocks protected by a patented active hardplate
- A handle activated locking mechanism consisting of two to six 1" chromed steel locking bolts
- Five boltwork sizes allow American Security to build units from 12" to 88" high, widths from 14" to 41"
- Solid steel dead bar prevents door removal if hinges are removed during a forced entry attempt
- Compact locking mechanism and boltwork cover allow for optional door mounted coin racks

HINGE FEATURES

- Fabricated from high strength steel with

precision machined alloy dowel pins

- Oil impregnated bronze bearing assures easy opening doors and reduced maintenance
- Vertical height adjustment

OPTIONAL FEATURES

- Spy proof dial
- Key lock dial
- Coin racks
- Managers lockers
- Interior lockers
- Interior drawers
- Adjustable shelves
- Electronic locks
- Auxiliary Key-Op locks
- Anchor bolt assembly
- Left swing door
- Internal rotary hopper
- Internal deposit slot
- Internal deposit chutes
- Hidden compartments
- Special sizes
- Custom colors



DXE1818

Model	Outside Dimension H" x W" x D"	Inside Dimension H" x W" x D"	Door Clearance H" x W"	Door Thickness	Body Thickness	Cubic Capacity	Weight	Lock Type
DXE1414†	15-½ x 15-½ x 16-¼	14-½ x 14-½ x 12-¼	13-½ x 13-¼	½	½	2,523 in.	240 lbs.	See pg. 52
DXE1818†	19-½ x 19-½ x 16-¼	18-½ x 18-½ x 12-¼	17-½ x 16-¾	½	½	4,107 in.	325 lbs.	See pg. 52
DXE2020†	21-½ x 21-½ x 24-¼	20-½ x 20-½ x 20-¼	19-½ x 18-¾	½	½	8,405 in.	464 lbs.	See pg. 52
DXE2420†	25-½ x 21-½ x 24-¼	24-½ x 20-½ x 20-¼	23-½ x 18-¾	½	½	10,045 in.	513 lbs.	See pg. 52
DXE2424XD†	25-½ x 25-½ x 28-¼	24-½ x 24-½ x 24-¼	23-½ x 18-¾	½	½	14,406 in.	635 lbs.	See pg. 52
DXE3018XD†	31-½ x 19-½ x 24-¼	30-½ x 18-½ x 20-¼	29-½ x 16-¾	½	½	11,285 in.	574 lbs.	See pg. 52
DXE3024†	31-½ x 25-½ x 24-¼	30-½ x 24-½ x 20-¼	29-½ x 16-¾	½	½	14,945 in.	673 lbs.	See pg. 52
DXE3030	31-½ x 31-½ x 24-¼	30-½ x 30-½ x 20-¼	29-½ x 28-¾	½	½	18,605 in.	770 lbs.	See pg. 52
DXE4024	41-½ x 25-½ x 24-¼	40-½ x 24-½ x 20-¼	39-½ x 22-¾	½	½	19,845 in.	821 lbs.	See pg. 52
DXE4524	46-½ x 25-½ x 24-¼	45-½ x 24-½ x 20-¼	44-½ x 22-¾	½	½	22,295 in.	897 lbs.	See pg. 52
DXE5030	51-½ x 31-½ x 24-¼	50-½ x 30-½ x 20-¼	49-½ x 28-¾	½	½	30,805 in.	1,103 lbs.	See pg. 52
DXE5224	53-½ x 25-½ x 24-¼	52-½ x 24-½ x 20-¼	51-½ x 22-¾	½	½	25,725 in.	1,100 lbs.	See pg. 52
DXE6030	61-½ x 31-½ x 24-¼	60-½ x 30-½ x 20-¼	59-½ x 28-¾	½	½	36,905 in.	1,274 lbs.	See pg. 52
DXE7234	73-½ x 35-½ x 30-¼	72-½ x 34-½ x 26-¼	71-½ x 32-¾	½	½	65,033 in.	1,775 lbs.	See pg. 52

AMVAULTX6 TL-30X6 HIGH SECURITY SAFE

AMVAULT TL-30X6 HIGH SECURITY SAFE



The Amvaultx6 U.L. Listed TL-30x6, six-sided high security composite safes are made in the United States using the latest testing procedures set forth by Underwriters Laboratories.

The new revolutionary Amvaultx6 is constructed with a 3" defense barrier of inner and outer steel plates enclosing a unique interlocking heavy duty steel barrier, high strength concrete exceeding 12,000 PSI and a high density high-strength ceramic matrix.

The high density insulating materials incorporated in the door and body also insure two hours of certified fire protection. The superior design and craftsmanship make the new Amvaultx6 impervious to burglary attacks attempted by the most sophisticated equipment utilized today and the vaults contents against intense fires.

COLOR(S): Comes standard in charcoal gray. Please refer to price book for pricing on premium colors.



CFX452020 shown with aux key lock

Model	Outside Dimension H" x W" x D"	Inside Dimension H" x W" x D"	Door Clearance H" x W"	Door Thickness	Body Thickness	Cubic Capacity	Weight	Lock Type
CFX252016	31 x 26 x 25-1/4	25 x 20 x 16	25 x 20	3	3	4.6 ft.	1,433 lbs.	See pg. 52
CFX352020	41 x 26 x 29-1/4	35 x 20 x 20	35 x 20	3	3	8.1 ft.	1,946 lbs.	See pg. 52
CFX452020	51 x 26 x 29-1/4	45 x 20 x 20	45 x 20	3	3	10.4 ft.	2,343 lbs.	See pg. 52
CFX582820	64 x 34 x 29-1/4	58 x 28 x 20	58 x 28	3	3	18.8 ft.	3,418 lbs.	See pg. 52
CFX703620	76 x 42 x 29-1/4	70 x 36 x 20	70 x 36	3	3	29.2 ft.	4,578 lbs.	See pg. 52

Add 2-1/2" to outside depth for handle, dial and hinge projection. Optional 3-way boltwork available on the CFX line.

AMVAULT TL-15 AND TL-30

AMVAULT FIRE RATED COMPOSITE SAFES



During extreme testing procedures, AMVAULT COMPOSITE SAFES demonstrated the ability to withstand severe attacks by experienced U.L. experts using powerful tools such as sledgehammers, power saws, carbide disc cutters, drills, etc., and without fail, were awarded the U.L. TL-15 and TL-30 labels.

Besides withstanding the most concentrated attacks by sophisticated burglars, each AMVAULT safe offers a Two Hour, 350° F factory fire test certification, ensuring the protection of the vault's contents against intense fires.

DOOR FEATURES

- Overall thickness of 6" and is constructed with a 3" defense barrier of outer and inner steel plates creating a single structure enclosing a unique, high density fire and burglary resistant composite material
- Defense barrier houses a proprietary amalgamation of nuggets and steel fibers to withstand concentrated attacks with the most sophisticated equipment used by burglars today
- Heavy duty pull handle standard on all CE/CF Models

BODY FEATURES

- The AmVault formed body has a total protective thickness of 3½" enclosing a high density fire resistant composite material with nuggets and steel fibers
- A reinforced drill resistant door frame protects the door and each individual bolt chamber from severe side attacks

- A proprietary inner barrier protects against peeling attacks
- High strength adjustable shelves with powder coated dark gray finish

FIRE ENDURANCE

- Two hour, 350°F factory fire rating. Tested at temperatures up to 1850°F

LOCKING MECHANISM

- Equipped with six or ten massive 1½" diameter chrome plated solid steel locking bolts. Each bolt moves deep into the body's protected bolt chambers
- Entire boltwork mechanism is also protected by a spring operated boltwork detent system. Bolts stay in the retracted position when the door is opened and automatically engage when the door is closed

THREE-WAY BOLTWORK OPTION

- Safes can be equipped with a three way active boltwork mechanism engaging the bolts horizontally and vertically into the body of the safe (except model 1814)

LOCK FEATURES

- Equipped with a U.L. listed Group 2M key changeable combination lock. The lock is protected by a massive drill shattering hard plate and two additional spring-loaded devices

HINGE FEATURES

- Offers a vertical height adjustment and utilizes an oil impregnated bearing ensuring easy door operation

OPTIONAL AUXILIARY KEY LOCK

- U.L. listed, high security auxiliary key lock is also available on all AMVAULT safes (except Model 1814). Lock is equipped with 2 keys and escutcheon cover
- An additional spring-loaded relock device protecting lock against punch attacks

OPTIONAL GLASS

RELOCKING MECHANISM

- Incorporated into the AMVAULT TL-30 auxiliary key lock is an optional high security tempered glass relock mechanism with a remotely and randomly placed "cross locking" relocking bolt and thermal cords to protect against torch attacks
- In the event of an attack by tools, torches, or explosives, the glass will shatter activating the highly sophisticated relock mechanism
- Utilizing the glass relock mechanism can offer up to a total of six different relock devices offering the ultimate in high security protection (except model 1814. Aux lock required)

OTHER OPTIONS

- Stor-It cabinets available in CE and CF models 2518, 3524, 5524, 6528, 7236
- Fully upholstered safe interior kits available for these models
- Optional premium upgrade package available. See page 10 for details

COLOR(S): Comes standard in Textured Charcoal Gray. Please refer to price book for pricing on premium colors.



CF1814



CE6528



CF7236

AMVAULT TL-15 AND TL-30

SAFE SPECIFICATIONS



AMVAULT High Security Composite safes have passed Underwriter's Laboratories most recent testing procedures ensuring you today's best protection. AMVAULT TL-15 and TL-30 U.L. listed composite

safes qualify for Mercantile & Broadform Insurance Class ER (TL-15) and F (TL-30) with a Bank Rating of BR (TL-15) and G (TL-30). Two Hour Class 350°F manufacturers' fire label.

Model TL-15	Outside Dimension H" x W" x D"	Inside Dimension H" x W" x D"	Door Clearance H" x W"	Door Thickness	Body Thickness	Cubic Capacity	Weight	Lock Type
CE1814**	25 x 21 x 21-½	18 x 14 x 12	18 x 14	3	3-½	1.8 ft.	710 lbs.	See pg. 52
CE2518	32 x 25 x 25-½	25 x 18 x 16	25 x 18	3	3-½	4.2 ft.	1,105 lbs.	See pg. 52
CE3524	42 x 31 x 29-½	35 x 24 x 20	35 x 24	3	3-½	9.7 ft.	1,674 lbs.	See pg. 52
CE4524	52 x 31 x 29-½	45 x 24 x 20	45 x 24	3	3-½	12.5 ft.	2,200 lbs.	See pg. 52
CE5524	62 x 31 x 29-½	55 x 24 x 20	55 x 24	3	3-½	15.3 ft.	2,343 lbs.	See pg. 52
CE6528	72 x 35 x 29-½	65 x 28 x 20	65 x 28	3	3-½	21.1 ft.	3,153 lbs.	See pg. 52
CE7236	79 x 43 x 32-½	72 x 36 x 23	72 x 36	3	3-½	34.5 ft.	3,880 lbs.	See pg. 52

Model TL-30	Outside Dimension H" x W" x D"	Inside Dimension H" x W" x D"	Door Clearance H" x W"	Door Thickness	Body Thickness	Cubic Capacity	Weight	Lock Type
CF1814**	25 x 21 x 21-½	18 x 14 x 12	18 x 14	3	3-½	1.8 ft.	758 lbs.	See pg. 52
CF2518	32 x 25 x 25-½	25 x 18 x 16	25 x 18	3	3-½	4.2 ft.	1,195 lbs.	See pg. 52
CF3524	42 x 31 x 29-½	35 x 24 x 20	35 x 24	3	3-½	9.7 ft.	1,908 lbs.	See pg. 52
CF4524	52 x 31 x 29-½	45 x 24 x 20	45 x 24	3	3-½	12.5 ft.	2,311 lbs.	See pg. 52
CF5524	62 x 31 x 29-½	55 x 24 x 20	55 x 24	3	3-½	15.3 ft.	2,679 lbs.	See pg. 52
CF6528	72 x 35 x 29-½	65 x 28 x 20	65 x 28	3	3-½	21.1 ft.	3,359 lbs.	See pg. 52
CF7236	79 x 43 x 32-½	72 x 36 x 23	72 x 36	3	3-½	34.5 ft.	4,426 lbs.	See pg. 52

Add 2-½" to outside depth for handle, dial and hinge projection. **Models 1814 can not be equipped with an auxiliary lock, 3-way boltwork or glass relock mechanism. Left swing models: After model #, use suffix L.

UNDERWRITERS LABORATORIES' BURGLARY RATING CLASSIFICATION

U.L. LABEL — BURGLARY CLASSIFICATION

TL-15:

Signifies a combination-locked safe designed to offer a limited degree of protection against attack by common mechanical and electrical hand tools and any combination of these means:

CONSTRUCTION REQUIREMENTS

- U.L. listed Group 2M, 1 or 1R combination lock or Type 1 Electronic lock
- 750 lbs. minimum or comes with instructions for anchoring in a larger safe, concrete blocks or on the premises where used
- Body walls of material equivalent to at least 1" open hearth steel with a minimum tensile strength of 50,000 P.S.I.

- Walls fastened in a manner equivalent to continuous ¼" penetration weld of open hearth steel with minimum tensile strength of 50,000 P.S.I.
- One hole ¼" or less, to accommodate electrical conductors arranged to have no direct view of the door or locking mechanism

PERFORMANCE REQUIREMENTS

Successfully resist entry* for a net working time of 15 minutes when attacked with common hand tools, picking tools, mechanical or portable electric tools, grinding points, carbide drills and pressure applying devices or mechanisms.

U.L. LABEL — BURGLARY CLASSIFICATION

TL-30:

Signifies a combination-locked safe designed to offer a moderate degree of protection against attack by common mechanical and electrical hand tools and any combination of these means.

CONSTRUCTION REQUIREMENTS

Same as TL-15

PERFORMANCE REQUIREMENTS

Successfully resist entry* for a net working time of 30 minutes when attacked with common hand tools, picking tools, mechanical or portable electric tools, grinding points, carbide drills and pressure applying devices or mechanisms, abrasive cutting wheels and power saws.

*Entry—Safes classed as TL-15 — opening the door or making a six square inch opening entirely through the door or front face. Safes classed as TL-30 — opening the door or making a six square inch opening entirely through the door or front face.

AMVAULT TL-15 & TL-30

CEV SERIES COMPOSITE SAFES



The all CEV series composite safes provides an economical alternative to the domestically built AmVaults from American Security. Like their domestic counterparts, the all new CEV import offers a UL TL-15 burglary rating and 2-hour fire protection.

Besides withstanding the most concentrated attacks by sophisticated burglars, each CEV safe offers a Two Hour, 350° F factory fire test certification, ensuring the protection of the vault's contents against intense fires.

DOOR FEATURES

- Heavy duty construction with tri-spoke handle and pull handle on all models
- Standard 6" overall door thickness with a barrier of outer and inner steel plates creating a single structure enclosing a unique, high density fire and burglary resistant composite material
- Defense barrier houses a proprietary

amalgamation of nuggets and steel fibers to withstand concentrated attacks with the most sophisticated equipment used by burglars today

BODY FEATURES

- Total protective thickness of 3½" enclosing a high density fire resistant composite material with nuggets and steel barriers
- A single ½" recessed stepped Anchor Hole centered in the bottom
- High strength adjustable steel shelves with powder coated dark gray finish

LOCKING MECHANISM FEATURES

- Equipped with a ESL10 electronic lock
- Equipped with six to ten massive 1½" diameter chrome plated solid steel locking bolts. Each bolt moves deep into the body's protected bolt chambers

COLOR(S): Comes standard in Textured Black.

*No customizations available on imported safes.



CEV1814



CEV2518



CEV5524



CEV6528



CEV3524

Model	Outside Dimension H" x W" x D"	Inside Dimension H" x W" x D"	Door Clearance H" x W"	Door Thickness	Body Thickness	Cubic Capacity	Weight	Lock Type
CEV1814	25 x 21 x 21-½"	18 x 14 x 12"	18 x 14"	6"	3-½"	1.8 ft.	710 lbs.	ESL10
CEV2518	32 x 25 x 25-½"	25 x 18 x 15-¾"	25 x 18"	6"	3-½"	4.2 ft.	1,105 lbs.	ESL10
CEV3524	42 x 31 x 29-½"	35 x 24 x 15-¾"	35 x 24"	6"	3-½"	9.7 ft.	1,674 lbs.	ESL10
CEV5524	62 x 31 x 29-½"	55 x 24 x 20"	55 x 24"	6"	3-½"	15.3 ft.	2,768 lbs.	ESL10
CEV6528	72 x 35 x 29-½"	65 x 28 x 20"	65 x 28"	6"	3-½"	21.1 ft.	2,866 lbs.	ESL10

MAX 15 COMPOSITE SAFES

MAX15 COMPOSITE SAFES



Our MAX15 SERIES COMPOSITE SAFES have been awarded the U.L. TL-15 label after withstanding concentrated attacks by experienced U.L. experts using powerful tools, such as sledgehammers, power saws, carbide disc cutters and drills.

In addition to providing excellent burglary protection, our MAX15 SAFE offers a 90-Minute ETL Intertek verified fire rating, ensuring your valuables are safe from intense fires.

DOOR FEATURES

- Constructed with a 2" defense barrier of outer and inner steel plates enclosing a unique, high-density fire and burglary resistant composite material
- Defense barrier houses a proprietary amalgam of nuggets and steel barriers to withstand concentrated attacks from the most sophisticated equipment used by burglars today

BODY FEATURES

- Total protective thickness of 2 13/16" enclosing a high density fire resistant composite material with nuggets and steel barriers
- A reinforced drill resistant door frame protects the door and each individual bolt chamber from severe side attacks
- A proprietary inner steel barrier protects against peeling attacks

- High-strength adjustable shelves with charcoal gray finish
- Equipped with a recessed 9/16" diameter anchor hole

FIRE ENDURANCE

- 90-minute Intertek verified fire rating

LOCKING MECHANISM

- Four-way active boltwork mechanism engages the bolts horizontally and vertically into the body of the safe
- Equipped with 6 1 1/2" diameter polished stainless steel locking bolts. Each bolt moves deep into the body's protected bolt chambers

LOCK FEATURES

- Equipped with the ESL10 U.L. Listed Type 1 electronic lock. The lock is protected by an internal relock mechanism and a massive drill-shattering hardplate
- The lock and vital mechanism areas are also protected by a high-security tempered glass plate with a remotely placed spring-loaded relocking bolt
- In the event of an attack by tools or explosives, the glass will shatter, activating the highly sophisticated relock mechanism

HINGE FEATURES

- Heavy-duty steel hinges provide smooth door operation

COLOR(S): Charcoal gray textured finish

*No customizations available on imported safes.



MAX1014

Model	Outside Dimension H" x W" x D"	Inside Dimension H" x W" x D"	Door Clearance H" x W"	Door Thickness	Body Thickness	Cubic Capacity	Weight	Lock Type
MAX1014	15-7/8 x 19-3/4 x 19-3/8	10-1/8 x 14-1/8 x 11-1/2	10-1/8 x 14-1/8	2	2-3/8	0.95 in.	485 lbs.	ESL10

ACE TL-15 SERIES MONEY CHEST

ACETL-15 U.L. LISTED FIRE RATED MONEY CHEST



American Security TL-15 U.L. Listed MONEY CHESTS qualify for Mercantile & Broadform Insurance Class ER (TL-15) with a banking rating of BR (TL-15). American Security MONEY CHESTS offer the highest level of security available with many outstanding features and a wide range of options.

DOOR FEATURES

- 5½" thick door constructed of outer and inner steel plates enclosing a high density proprietary composite material
- Two hour, 350°F factory fire rating. Tested at temperatures up to 1850°F

BODY FEATURES

- 3¼" thick body constructed of inner and outer steel plates enclosing a high density proprietary composite material

- Door and inner jamb surrounded by thick solid steel bars

LOCKING MECHANISM FEATURES

- U.L. listed Group 2M key changeable lock, with relock and 1 million possible combinations
- Single auxiliary spring-loaded reloading device, activated by a punching attack
- Locks and relocks protected by a large proprietary drill shattering active hardplate
- A handle activated locking mechanism consisting of three to five 1" diameter chromed steel locking bolts
- Five boltwork sizes allow American Security to build units from 12" to 82" high, widths from 18" to 48" (interior dimensions)
- Solid steel dead bars prevent door removal if hinges are removed during a forced entry attempt
- Compact locking mechanism allows for optional door mounted coin racks

HINGE FEATURES

- Ball bearing hinges fabricated from high strength steel
- Precision machined alloy dowel pins
- Oil impregnated bronze bearing assures easy opening doors and reduced maintenance
- Vertical height adjustment

OPTIONS

- Coin racks • Managers lockers
- Interior lockers • Interior drawers
- Adjustable shelves
- Anchor bolt assembly • Left swing door
- Internal rotary hopper • Internal deposit slot
- Internal deposit chutes
- Hidden compartments
- Special sizes • Custom colors

COLOR(S): Charcoal Gray is the standard color. Other colors can be quoted upon request.

Model	Outside Dimension H" x W" x D"	Inside Dimension H" x W" x D"	Door Clearance H" x W"	Door Thickness"	Body Thickness"	Cubic Capacity	Weight	Lock Type
ACE 2020	26-¾ x 26-½ x 29	20 x 20 x 20	19 x 18-¾	3	3-¼	8,000 in.	1,047 lbs.	See pg. 51
ACE 2020XD	26-¾ x 26-½ x 33	20 x 20 x 24	19 x 18-¾	3	3-¼	9,600 in.	1,150 lbs.	See pg. 51
ACE 3020	36-¾ x 26-½ x 29	30 X 20 X 20	29 x 18-¾	3	3-¼	12,000 in.	1,130 lbs.	See pg. 51
ACE 3020XD	36-¾ x 26-½ x 33	30 X 20 X 24	29 x 18-¾	3	3-¼	14,400 in.	1,454 lbs.	See pg. 51
ACE 4024	46-¾ x 30-½ x 29	40 X 24 X 20	39 x 22-¾	3	3-¼	19,200 in.	1,784 lbs.	See pg. 51
ACE 4024XD	46-¾ x 30-½ x 33	40 X 24 X 24	39 x 22-¾	3	3-¼	23,040 in.	1,937 lbs.	See pg. 51
ACE 5024	56-¾ x 30-½ x 29	50 X 24 X 20	49 x 22-¾	3	3-¼	24,000 in.	2,091 lbs.	See pg. 51
ACE 5024XD	56-¾ x 30-½ x 33	50 X 24 X 24	49 x 22-¾	3	3-¼	28,800 in.	2,266 lbs.	See pg. 51
ACE 6030	66-¾ x 36-½ x 29	60 X 30 X 20	59 x 28-¾	3	3-¼	36,000 in.	2,725 lbs.	See pg. 51
ACE 6030XD	66-¾ x 36-½ x 35	60 X 30 X 26	59 x 28-¾	3	3-¼	46,800 in.	3,040 lbs.	See pg. 51



ACF4824DS



ACE with two door

ACF TL-30 SERIES MONEY CHEST

ACFTL-30 U.L. LISTED FIRE RATED MONEY CHEST



American Security TL-30 U.L. Listed MONEY CHESTS qualify for Mercantile & Broadform Insurance Class F (TL-30) with a banking rating of G (TL-30). American Security MONEY CHESTS offer the highest level of security available with many outstanding features and a wide range of options.

DOOR FEATURES

- 5½" thick door constructed of outer and inner steel plates enclosing a high density proprietary composite material
- Two hour, 350°F factory fire rating. Tested at temperatures up to 1850°F

BODY FEATURES

- 3¼" thick body constructed of inner and outer steel plates enclosing a high density proprietary composite material

- Door and inner jamb surrounded by thick solid steel bars

LOCKING MECHANISM FEATURES

- U.L. listed Group 2M key changeable lock, with relock and 1 million possible combinations
- Single auxiliary spring-loaded relocking device, activated by a punching attack
- Locks and relocks protected by a large proprietary drill shattering active hardplate
- A handle activated locking mechanism consisting of three to five 1" diameter chromed steel locking bolts
- Five boltwork sizes allow American Security to build units from 12" to 82" high, widths from 18" to 48" (interior dimensions)
- Solid steel dead bars prevent door removal if hinges are removed during a forced entry attempt
- Compact locking mechanism allows for optional door mounted coin racks

HINGE FEATURES

- Ball bearing hinges fabricated from high strength steel
- Precision machined alloy dowel pins
- Oil impregnated bronze bearing assures easy opening doors and reduced maintenance
- Vertical height adjustment

OPTIONS

- Coin racks • Managers lockers
- Interior lockers • Interior drawers
- Adjustable shelves • Anchor bolt assembly
- Left swing door
- Internal rotary hopper • Internal deposit slot
- Internal deposit chutes
- Hidden compartments
- Special sizes • Custom colors

COLOR(S): Charcoal Gray is the standard color. Other colors can be quoted upon request.

Model	Outside Dimension H" x W" x D"	Inside Dimension H" x W" x D"	Door Clearance H" x W"	Door Thickness	Body Thickness	Cubic Capacity	Weight	Lock Type
ACF 2020	26-¾ x 26-½ x 29	20 x 20 x 20	19 x 18-¾	3	3-¼	8,000 in.	1,069 lbs.	See pg. 51
ACF 2020XD	26-¾ x 26-½ x 33	20 x 20 x 24	19 x 18-¾	3	3-¼	9,600 in.	1,170 lbs.	See pg. 51
ACF 3020	36-¾ x 26-½ x 29	30 X 20 X 20	29 x 18-¾	3	3-¼	12,000 in.	1,369 lbs.	See pg. 51
ACF 3020XD	36-¾ x 26-½ x 33	30 X 20 X 24	29 x 18-¾	3	3-¼	14,400 in.	1,492 lbs.	See pg. 51
ACF 4024	46-¾ x 30-½ x 29	40 X 24 X 20	39 x 22-¾	3	3-¼	19,200 in.	1,849 lbs.	See pg. 51
ACF 4024XD	46-¾ x 30-½ x 33	40 X 24 X 24	39 x 22-¾	3	3-¼	23,040 in.	2,003 lbs.	See pg. 51
ACF 5024	56-¾ x 30-½ x 29	50 X 24 X 20	49 x 22-¾	3	3-¼	24,000 in.	2,176 lbs.	See pg. 51
ACF 5024XD	56-¾ x 30-½ x 33	50 X 24 X 24	49 x 22-¾	3	3-¼	28,800 in.	2,351 lbs.	See pg. 51
ACF 6030	66-¾ x 36-½ x 29	60 X 30 X 20	59 x 28-¾	3	3-¼	36,000 in.	2,847 lbs.	See pg. 51
ACF 6030XD	66-¾ x 36-½ x 35	60 X 30 X 26	59 x 28-¾	3	3-¼	46,800 in.	3,162 lbs.	See pg. 51

ACFTL-30 2-HOUR FIRE RATED DEPOSITORY SAFE



American Security's ACF TL-30 TWO DOOR DEPOSITORY SAFE offers complete cash management versatility for any operation that requires a nonreturnable deposit such as armored car companies, convenience stores, restaurants, etc. The U.L. listed TL-30 composite construction offers peace of mind when overnight protection is required.

TOP DEPOSIT/STORAGE COMPARTMENT

- Outer door equipped with a U.L. listed Group 2M combination lock and chrome plated front read dial
- Large storage capacity: accommodates up to nine cash register trays
- Large 3" x 18" deposit chute is protected by an "anti-fish", saw-tooth, hinged baffle
- Two adjustable shelves
- Door mounted 4-opening rolled coin storage rack

BOTTOM RECEIVING COMPARTMENT

- Outer door equipped with a U.L. listed Group 2M combination lock, chrome plated front read dial and an auxiliary key-op lock for dual control or armored car pick up

OPTIONS

- Interior lockers, Interior drawers
- Custom sizes/designs

Model	Outside Dimension H" x W" x D"	Inside Dimension H" x W" x D"	Door Clearance H" x W"	Door Thickness	Body Thickness	Cubic Capacity	Weight	Lock Type
ACF4824DS	47-¾ x 24-½ x 26	TOP 26 x 18 x 14 BTM 14 x 18 x 17	25 x 16-¾ 13 x 16-¾	3	3-¼	6,552 in. 4,284 in.	1,746 lbs.	Group 2M Combination Lock Both Doors & AUX Key Lock Bottom Compartment

PHARMACY SAFES

PHARMACY SAFES

American Security's complete line of PHARMACY SAFES offer a great solution for keeping your high-value, high-target medications and facility safe from the devastating occurrence of a robbery, burglary or internal theft. Choose from several models that are ideal for small to larger sized pharmacies, hospitals or health care facilities.

NARCO3824 SINGLE DOOR PHARMACY SAFE FEATURES

- One outer door with a three-way locking system
- Designed to easily replace a standard wooden pharmacy cabinet
- Six (6) roll-out trays with four (4) full width & depth adjustable dividers
- Lock status Time Delay Indicator box with 50 ft. cable
- B-rated burglar-resistive classification
- Three-way locking mechanism with five (5) 1" dia. locking bolts
- Four (4) 5/8" dia. anchor holes
- Pharmacy white paint finish
- AC power standard



NARCO3824

NARCO3839 TWO DOOR PHARMACY SAFE FEATURES

- Two outer doors made of solid 1/4" steel with four heavy duty hinges and a three way locking system
- Designed to easily replace a standard wooden pharmacy cabinet
- Ten (10) roll out trays
- Lock status Time Delay Indicator box with 10 ft. cable
- B-rated burglar-resistive classification
- Single auxiliary spring loaded relock device, activated by a punch attack
- Heavy-duty three point locking mechanism
- Cabinet mounted directly onto the floor with 4 anchor holes
- Warning label included
- AC power standard



NARCO3839

NARCO8336 FOUR DOOR PHARMACY SAFE

- Four (4) outer doors made of Polycarbonate and 1/4" steel with a three-way locking system
- Designed to easily replace a standard wooden pharmacy cabinet
- 24 shelves
- Shelves are adjustable up and down
- Lock status Time Delay Indicator box with 50 ft. cable
- B-rated burglar-resistive classification
- Single auxiliary spring loaded relock device, activated by a punch attack
- Heavy-duty three point locking mechanism
- Cabinet mounted directly onto the floor with 16 anchor holes – (4) top, bottom, and side drilled
- Warning label included
- Two piece design for easy installation
- AC power standard

Model	Outside Dimension H" x W" x D"	Inside Dimension H" x W" x D"	Door Clearance H" x W"	Door Thickness	Body Thickness	Cubic Capacity	Weight	Lock Type
NARCO3824	38 x 24 x 23	33-3/4 x 23-3/4 x 20-1/2	30-1/4 x 20-1/4	4 GA	11 GA	16,131.45"	438 lbs.	ESLAudit II
NARCO3839	38 x 39 x 22	37-3/4 x 19-5/8 x 19-1/2	34-1/4 x 16-3/8	4 GA	11 GA	27,886.04"	500 lbs.	ESLAudit II
NARCO8336	83 x 36 x 15-3/4	41-1/4 x 17-3/16 x 12-7/8	37-3/4 x 14-7/8	4 GA	11 GA	18,920.21"	660 lbs.	ESLAudit II

OPTIONAL EXTRAS

INTERIOR DRAWERS/LOCKERS/HOPPERS

INTERIOR DRAWERS

All drawers are commercial quality, heavy steel construction. Available in letter, legal and document sizes. Each is furnished with handle and key lock. All drawer capacities are 100 lbs. and come with a heavy duty latch removable ball bearing suspension.



INTERIOR LOCKERS

Offers a wide variety of standard interior locker compartments to fit your needs. Standard lockers are constructed of 11 gauge or ¼" solid steel. Options include slotted doors, combination locks and high security key locks.

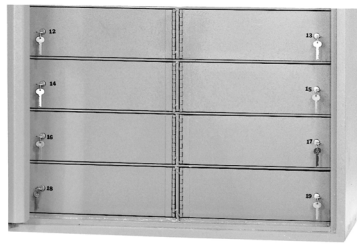

INTERIOR/EXTERIOR HOPPER

Available in three different package sizes ranging from 5¾" D x 3½" W x 8¾" L to 7" D x 4½" W x 10¾" L. Hoppers can be installed on the interior or exterior of plate, clad or composite safes.

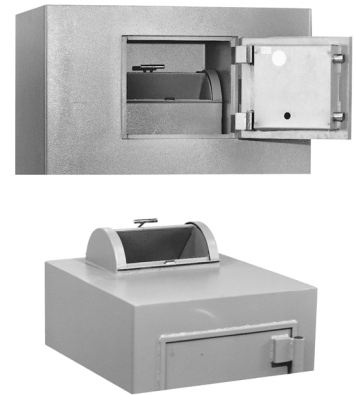

MODULAR ALARM SYSTEM/ OPTIONS

MODULAR ALARM

Detects vibration, heat and door openings. Heat indicator activates alarm when torch attack occurs. Internal magnetic door contact detects door opening. Internal vibration sensor activates alarm if safe is moved or during drill attack.

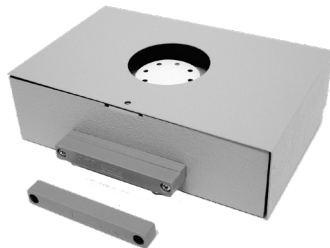

LOCKING BOLT DETENT

Keeps locking bolts retracted when door is in open position. Prevents damage to safe body and boltwork mechanism caused by accidental door closure with bolts extended.

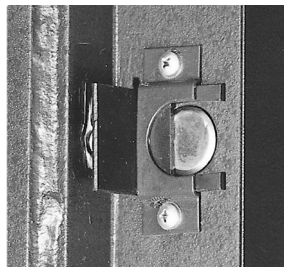

COIN RACKS

For organized storage of coins. Mounted on inside safe door. Available with four or six compartments.



ELECTRONIC LOCKS

SAFEWIZARD II®

SafeWizard II is the most flexible and powerful safe access control system available.

SECURITY

- All components communicate through an encrypted network
- Large high-contrast LCD display
- Supports dual control and armored car pickups
- Supports time delay as a deterrent to robberies
- Supports time lock restricted access to defined operating hours
- 120,000-record audit trail supports up to 500 users, each of whom can have unique privileges
- PIN code and/or e-Key for user authentication
- Door and bolt sensors detect if a door has been left open
- Battery backup for 8 hours of power-out operation
- Backup database secured inside of safe

FLEXIBILITY

- Network access via Ethernet or Wi-Fi connection
- Local firmware upgrades via USB
- Supports up to 12 locks and one deposit lock
- Supports swing and toggle locks
- Multiple lock designs to support access control of safe doors, lockers and drawers
- Each lock can be individually configured for all access control parameters and user access
- Alarm interface
- Four language options: English, French, German, Spanish

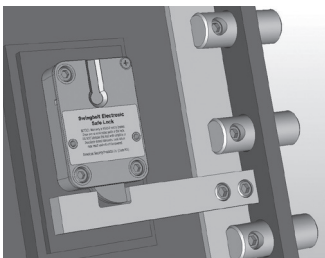

SWING BOLT LOCK

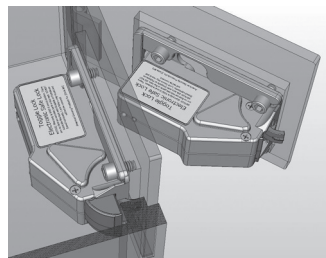

TOGGLE LOCK

ELECTRONIC LOCKS

ESLAUDIT II

ESLAudit II U.L. Listed Type 1 Electronic Lock makes it easy to manage safe access with its integrated USB Port.

SECURITY

- U.L. Listed Type 1
- All components communicate through an encrypted network
- Supports dual control and armored car pickups
- Supports time delay as a deterrent to robberies
- Supports time lock restricted access to defined operating hours
- Supports alarm output or duress alarm
- 5,000-record audit trail
- Supports up to 99 users, each of whom can have unique privileges

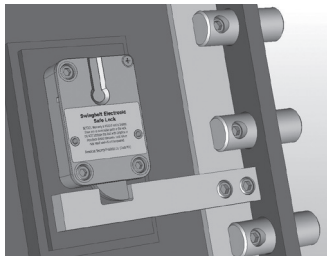

SWING BOLT LOCK

- PIN code and/or electronic keys for user authentication
- Optional door sensor detects if door is left open
- Back-up database secured inside of safe

FLEXIBILITY

- Retrofits most mechanical or electronic locks
- Supports Swingbolt and Toggle locks
- Controls up to 4 doors
- Safe doors can be configured in an inner/outer door configuration
- Authentication options: PIN and/or e-Key
- 9-volt battery and optional AC power
- Optional remote time delay indicator
- Update firmware via USB port

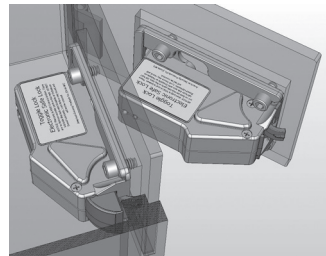

TOGGLE LOCK

POWERFUL PC APPLICATION

- Manage users
- View and store audit trails
- Manage system configuration
- Manage door settings



ESLAUDIT II



ESL5



ESL5

American Security is a pioneer in the electronic lock market, and the ESL5 ELECTRONIC LOCK offers unrivaled value in electronic safe access. The ESL5 lock has the best blend of features and function in electronic safe locks. The ESL5 offers attractive chrome or black nickel finish ABS housing with a backlit alphanumeric keypad. The ESL5 is a basic keypad lock for home and office applications.

FEATURES:

- Replaces most mechanical combination locks. Easy installation and operation
- U.L. Listed ESL5 has an attractive chrome or black nickel finish ABS housing with a backlit alphanumeric keypad. Factory Reset Combination for resolving lost combinations without requiring expensive service calls
- Electronics are encapsulated within the lock and are sealed to prevent possible moisture related failures
- Cable fits through a 1/2" spindle hole without cutting and re-crimping connector
- Beep and flash from every keystroke gives maximum feedback to the user
- Lock can be programmed to silence the beep in stealth mode

- 15-Minute Penalty Lockout after four incorrect entries protects against manipulation attempts
- New swing bolt reversible lock design for right or left-handed installation
- Lock "auto-locks" when boltwork is thrown to prevent safes from being left in a day-lock position
- One 9-volt battery can be easily replaced in the keypad housing

COLOR(S): Black Nickel or Chrome

ELECTRONIC LOCKS

ESL SERIES

American Security has been a pioneer in the electronic lock market. The ESL SERIES locks offer unrivaled value in electronic safe access. The ESL10 and ESL20 locks have the best blend of features and function in Electronic Safe Locks. The ESL SERIES offer an attractive metal die-cast keypad housing with an alpha-numeric slanted keypad. The ESL10 is a basic keypad lock for home and office applications. The ESL20 offers advanced features necessary for commercial applications.

ESL10 FEATURES

- Replaces most mechanical combination locks. Easy installation and operation
- Factory Reset Combination for solving lost combinations without requiring expensive service calls
- Electronics are encapsulated within the lock and are sealed to prevent possible moisture related failures
- Cable fits through a ½" spindle hole without cutting and re-crimping connector
- Audible beep and flash from every keystroke gives maximum feedback to the user
- 15 minute Penalty Lockout after four incorrect entries protects against manipulation attempts
- New patented dead-latched lock design with an internal relock device for maximum security
- Lock "auto-locks" when boltwork is thrown to prevent safes from being left in a day lock position
- Slam Bolt version for locker applications
- UL type 1

ESL20 ADDITIONAL FEATURES

- Time Delay Mode: Delays can be set from 1 to 99 minutes
- Multiple User Mode: When enabled, one Master code and eight user codes are available with full supervisory control and code management
- Dual Control Mode: The lock can be programmed to require two combinations to open for added security
- Armored Car Override: When enabled, allows an armored car service to bypass Time Delay



ESL20

COLOR(S):

ESL10: Black Nickel, Chrome, Brass, Black
ESL20: Black



ESL10

ELECTRONIC LOCKS

ROTOBOLT REDUNDANT SAFE LOCK

The new U.L. Listed LP Lock offers the convenience of an Electronic lock and the trusted reliability of a mechanical combination lock.

ELECTRONIC KEYPAD AND MECHANICAL DIAL

- Bright chrome finish
- Audible and visual feedback
- Durable Mylar keypad
- Spy-proof digital entry
- Sliding door access to battery compartment

ELECTRONIC LOCK

- U.L. Type 1
- 1 Manager and 1 User code
- 6 Digit changeable code
- Time Delay (1 to 99 minutes)
- Battery low indicator
- Manipulation protection

MECHANICAL LOCK

- U.L. Group 2M
- Manipulation resistant
- Standard mechanical lock footprint
- No spline key required

COMPATIBILITY

- Note: This lock is not reversible and will only mount on right swing – vertical down or left swing – vertical up locking systems
- Not available on all models. Please contact us for a complete list of compatible American Security safes



ROTOBOLT

LOCKS FROM KABA

American Security offers a variety of locks from manufacturers like Kaba. Please see American Security's Pricebook or talk to your local American Security sales representative for more information on what locks are available on American Security safes.

KABA[®]



AUDITCON[®]
ROUND PROFILE

LOCK COMPARISON CHART

AMERICAN SECURITY

	ESL5	ES5LP	ESL10	ESL20	ESLAudit II	SafeWizardII®
Keypad Housing	Round Backlit	N/A	Round	Round	Vertical Rectangle	Horizontal Rectangle
U.L. Listed	U.L. Type 1	U.L. Type 1	U.L. Type 1	U.L. Type 1	U.L. Type 1	Type 1
Number of Users	1	1	1	1 Master, 8 users, 1 Armored Car	40 Multiple User Opts. Reg. Mgr., Mgr. & Std. Users	500 Multiple User Opts. Reg. Mgr., Mgr. & Std. Users
Time Delay Override	No	No	No	Yes	Yes	Yes
Safe Doors	1	1	1	1	4	12
Power Source	(1) 9V No A/C Opt	(1) 9V No A/C Opt	(2) 9V No A/C Opt	(2) 9V No A/C Opt	(2) 9V A/C Opt	AC w/ Battery Back-up
Combination (# of digits)	6	6	6	6	Key + 6 Digits 8 if Keypad only	Key + 6 Digits 8 if Keypad only
Wrong Try Lock Out (time)	Yes (15 min.)	Yes (15 min.)	Yes (15 min.)	Yes (15 min.)	Yes- 4 attempts (15 min.)	Settable (user only)
Dual Mode	N/A	N/A	N/A	Yes	Yes	Yes
Time Delay	N/A	N/A	N/A	1-99 min.	1-99 min.	1-99 min.
Time Delay Open Input Window (time/by user)	N/A	N/A	N/A	1-9 min.	1-99 min.	1-99 min.
Time Lock (periods)*(variable)	N/A	N/A	N/A	N/A	(4) (*) Software set	(6) (*)
Duress	N/A	N/A	N/A	N/A	Opt	STD
Audit Trail (# of events)	N/A	N/A	N/A	N/A	Yes 5000 Time & Date Software Viewed	Yes 120,000 w/500 Backup Time & Date
PC Software Audit Records	N/A	N/A	N/A	N/A	(Opt.)	CLOUD (Opt.)
Alarm Interface	N/A	N/A	N/A	N/A	(Opt.)	Yes
Auto Lock	Yes	Yes	Yes	Yes	Yes	Yes
Bolt Options	Swing	Swing	Standard/Slam	Standard/Slam		

	LP LOCKS	SARGENT & GREENLEAF		KABA		
	Rotobolt	6123	6126	AuditCon 52	AuditCon 252	AuditCon 552
Keypad Housing	Round w/Combo Back Up	Round	Round	Round, Vertical	Round, Vertical	Round, Vertical
U.L. Listed	U.L. Type 1	U.L. Type 1	U.L. Type 1	U.L. Type 1	U.L. Type 1	U.L. Type 1
Number of Users	1 w/ 3 or 4 Number Combo Back Up	5	1 Programmer, 3 Manager, 6 Super User, 20 User	2	20	99
Time Delay Override	N/A	Yes	Yes	No	Yes	Yes
Safe Doors	1	1	1	1	1	1
Power Source	(1) 9V No A/C	(2) 9V	(2) 9V	Self Generating/Battery	Self Generating	Self Generating
Combination (# of digits)	6 - 3 or 4 Num. Combo	6	6	6	8	8
Wrong Try Lock Out (time)	Yes (5 min)	4 (15 min)	5 (10 min)	Yes (3 min)	Yes (3 min)	Yes (3 min)
Dual Mode	N/A	Yes	Yes	Yes	Yes	Yes
Time Delay	1-99 min. Fact. Assist	1-99 min.	1-99 min.	Yes (Order Model T-52)	Yes	Yes
Time Delay Open Input Window (time/by user)	1-19 min. Fact. Assist	2-9 min.	1-10 min.	No	No	No
Time Lock (periods)*(variable)	N/A	N/A	N/A	N/A	N/A	N/A
Duress	N/A	Opt	Opt	Opt	Opt	Opt
Audit Trail (# of events)	N/A	N/A	Yes 400 Time & Date	No	Yes 100	Yes 400 Time & Date
PC Software Audit Records	N/A	No	(Opt) Audit Only	No	Yes (Opt) 100	Yes (Opt) 400
Alarm Interface	N/A	No	Yes	No	Yes (Opt)	Yes (Opt)
Auto Lock	Yes	Yes	Yes	Yes	Yes	Yes
Bolt Options	Swing	Standard Motor	Standard Motor	Slide/ Standard	Slide/ Standard	Slide/ Standard

MECHANICAL LOCKS AND KEY LOCKS

American Security offers a wide variety of options not listed here. Consult your American Security price book or call for other available options. American Security's staff will also assist in helping you choose the correct options for your security needs.

U.L. LISTED GROUP 2 MECHANICAL COMBINATION SAFE LOCK KIT

Mechanical Combination Safe Locks have been around for over 100 years and are very secure and reliable. With the proper care and service, the American Security mechanical combination safe lock will last a long time.

- Three brass and aluminum combination wheels provide 1,000,000 theoretical combinations
- Dual brass locking cams prevent wheel slippage
- Solid brass locking bolt and zinc drop lever
- Four-way brass drive cam allows mounting RH, LH, VU or VD
- Internal spring-loaded brass relock trigger guards against punch attacks

- Standard mounting footprint matches most mechanical and electronic safe locks
- Large front-read convertible dial and ring
- Both dial and ring are die cast with black finish and white letters
- A solid, machined brass spindle – 4 7/8"
- Can be converted to a key-locking dial with a disc tumbler key cylinder and two keys (shown at below)
- Comes standard with an attractive self-stick solid dial insert or a key-locking dial insert

SAFE LOCK KIT INCLUDES

- U.L. Listed Group 2 mechanical safe lock
- Large front-read convertible dial & ring, BW finish
- Non-key-locking dial insert
- Key-locking dial insert
- Key cylinder and two keys
- Package mounting hardware and two spline keys
- Combination change key
- Durable packaging and foam inserts protect contents from shipping damage



KEY LOCKING SPYPROOF DIAL
Restricts unauthorized viewing while dialing the combination, as well as providing dual custody control.



SPYPROOF DIAL
Restricts unauthorized viewing while dialing combination. Also available with key locking feature.



KEY LOCKING FRONT READ DIAL
Key is used to lock dial in a fixed position and affords dual custody control. Manager has the combination, collector has the key. Both must be present to unlock the safe.



Front Ready Dial
Safes equipped with Time Locks offer the capability of locking the safe for a pre-selected period of time. Time periods range from one hour to 144 hours (6 full days).

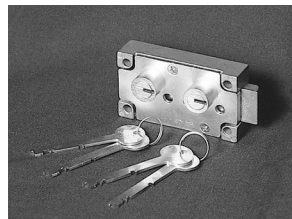

U.L. LISTED DUAL NOSE KEY LOCK
Dual control safe deposit lock requires two different keys to open safe.

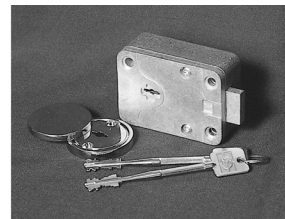

U.L. LISTED HIGH SECURITY KEY LOCK
European style nine-lever changeable key lock offers exceptional security features for use on inner locker or outer safe doors.

FIRE RATINGS

When it comes to fire protection nobody does it better than American Security! We've developed high security safes that earned the stringent Underwriters Laboratories UL half-hr., 1 hr. and 2 hr. fire endurance classifications and have tested and certified a 30 min., 45 min., 60 min., 90 min., and 120 min. series gun safes with Intertek ETL, the industry's leading independent laboratory for gun safe fire testing. When comparing fire ratings it is important to understand the following:

- Be sure to weigh reports from independent laboratories against unverified factory testing.
- Consumers looking for real fire protection should consider a safe that has been tested and certified by either Underwriters Laboratories (UL) or Intertek Laboratories (ETL).
- Verify the fire curve. Did the furnace hold its specified temperature early on in the test or ramp up near the end? A true 2-hr. fire test should show that within 8 minutes, the furnace temperature was raised to 1200° F, and that temperature was maintained for the remainder of the two-hour test.
- What type of door seals does the product offer? The best seal is a Palusol™ door seal that expands to 7 times its size when temperatures reach 212 degrees, sealing off both heat and smoke. Some top end products use dual seals utilizing a silicone seal as first defense protecting the safe until the Palusol™ seal performs its task.

Fire causes over 6 billion in property damages every year. The National Fire Protection Agency NFPA also reported that one home structure fire happens every 85 seconds. With alarming facts as these make sure you make the right choice.

The Best: Fire safes that are constructed with inner and outer steel plates enclosing a poured fire insulating material creating a seamless fire barrier. These safes offer superior fire protection and have been tested by either Underwriters Laboratories (UL rating) or Intertek (ETL).

Better: Fire safes are constructed with 2 to 4 assorted layers of gypsum board positioned throughout the interior body and door. These safes should be tested and verified by Intertek (ETL).

Good: Fire safes are constructed with 1 to 2 assorted layers of gypsum board positioned throughout the interior body and door. They typically offer a manufacturers independent fire rating.

FIRE ENDURANCE TEST

After heat sensors and paper are placed inside the safe, the unit is locked and exposed to a uniformly distributed fire. The furnace is regulated to reach a maximum temperature of 1700°F for a period of one hour, or 1850°F for two hours, then allowed to cool without opening the furnace. The interior temperature is recorded throughout the test and during the cooling period until a definite drop is shown and must never exceed 350°F.

Once cooled, the unit is opened and examined for usability. The units locking mechanisms and parts fastenings are examined for security and the interior examined for visible evidence of undue heat transmission.

EXPLOSION HAZARD TEST

The safe is locked and placed into a furnace preheated to 2000°F. This temperature is maintained for 30 minutes (2 hour test is 45 minutes) and if no explosion results, the unit is allowed to cool without opening the furnace doors. Once cooled, the unit is opened and examined for usability. The units locking mechanisms and parts fastenings are examined for security and the interior examined for visible evidence of undue heat transmission.

FIRE IMPACT TEST (MANUFACTURER'S OPTION)

After the explosion hazard test, the safe is removed from the furnace and within two minutes is dropped 30' onto a riprap of brick on a heavy concrete base. After impact, the unit is examined for deformation, rupture of parts, damaged insulation and any other openings into the interior of the unit. Once cooled, the unit is inverted and reheated to 1550°F for a period of 30 min. (2 hour test: 45 min. at 1638°F). Once cooled, the unit is opened and examined for usability. The units locking mechanisms and parts fastenings are examined for security and the interior examined for visible evidence of undue heat transmission.



U.L. FIRE RATING EXPLAINED

U.L. Label/Class 350°F-one hour and Class 350°F-two hour. The safe will maintain an interior temperature less than 350°F when exposed to fire for a period of one hour at 1700°F or for a period of two hours at 1850°F. Safe must successfully undergo all other requirements for the Fire Endurance Test, Explosion Hazard Test and the Fire Impact Test.



Intertek

ETL FIRE RATING EXPLAINED

ETL Testing Laboratories has been conducting performance and reliability tests since 1896. They are an internationally recognized with Labs in over 14 countries. Today Intertek ETL is the industry's leading independent laboratory for gun safe fire testing. When analyzing the fire performance of competitive gun safes, be sure to weigh reports from independent laboratories against unverified factory testing.

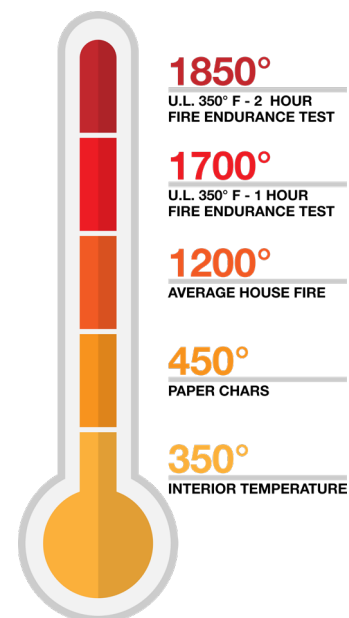

FIRE RATINGS



30 MINUTE RATING EXPLAINED

NEW ETL-INTERTEK LABORATORY TESTING CONFIRMS THAT AMERICAN SECURITY'S TF® GUN SAFES HAVE SUPERIOR FIRE PROTECTION FOR 30 MIN. AT 1,200°F.

American Security's TF Gun Safes are constructed 2 to 3 assorted layers of gypsum board positioned throughout the interior body and door. This superior fire protection was confirmed at ETL-Intertek, the industry's leading independent laboratory for gun safe fire testing. When analyzing the fire performance of competitive safes, be sure to weigh reports from independent laboratories against unverified factory testing or untested claims.

During fire testing, ETL-Intertek kept our TF Gun Safes in their test oven for 30 minutes. Within 8 minutes, the furnace temperature was raised to 1200° F, and that temperature was maintained for the remainder of the 30 minute test. This method is consistent with the UL-72 fire test. Typical house fires only reach temperatures of 1100° F. A safe is considered to have failed this test if temperatures exceed 350°F anywhere in the safe. Our safe passed the test as internal temperatures never exceeded 350° F during the 30 minute of testing. Paper typically starts to ignite at 450° F.

60 MINUTE RATING EXPLAINED

ETL-INTERTEK LABORATORY TESTING CONFIRMS THAT AMERICAN SECURITY'S SF® GUN SAFES HAVE SUPERIOR FIRE PROTECTION FOR 60 MINUTES AT 1,200°F.

American Security safes that receive a 60-minute fire rating, like the SF series of gun safes, are safes that have been tested and certified to meet or exceed performance metrics at a temperature of 1,200° F for at least 60 minutes. This superior fire protection was confirmed at ETL-Intertek, the industry's leading independent laboratory for gun safe fire testing. When analyzing the fire performance of competitive safes, be sure to weigh reports from independent laboratories against unverified factory testing or untested claims.

During fire testing, ETL-Intertek kept our BF Gun Safes in their test oven for two hours. Within 8 minutes, the furnace temperature was

raised to 1200° F, and that temperature was maintained for the remainder of the 60-minute test. This method is consistent with the UL-72 fire test. Typical house fires only reach temperatures of 1100° F. A safe is considered to have failed this test if temperatures exceed 350°F anywhere in the safe. Our safe passed the test as internal temperatures never exceeded 350° F during the 60 minutes of testing. Paper typically starts to ignite at 450° F.

90 MINUTE RATING EXPLAINED

ETL-INTERTEK LABORATORY TESTING CONFIRMS THAT AMERICAN SECURITY'S NF® GUN SAFES HAVE SUPERIOR FIRE PROTECTION FOR 90 MINUTES AT 1,200°F.

American Security's NF Gun Safes are constructed 3 to 4 assorted layers of gypsum board positioned throughout the interior body and door. This superior fire protection was confirmed at ETL-Intertek, the industry's leading independent laboratory for gun safe fire testing. When analyzing the fire performance of competitive safes, be sure to weigh reports from independent laboratories against unverified factory testing or untested claims.

During fire testing, ETL-Intertek kept our NF Gun Safes in their test oven for 90 minutes. Within 8 minutes, the furnace temperature was raised to 1200° F, and that temperature was maintained for the remainder of the 90 minute test. This method is consistent with the UL-72 fire test. Typical house fires only reach temperatures of 1100° F. A safe is considered to have failed this test if temperatures exceed 350°F anywhere in the safe. Our safe passed the test as internal temperatures never exceeded 350° F during the 90 minutes of testing. Paper typically starts to ignite at 450° F.

120 MINUTE RATING EXPLAINED

ETL-INTERTEK LABORATORY TESTING CONFIRMS THAT AMERICAN SECURITY'S BF® GUN SAFES HAVE SUPERIOR FIRE PROTECTION FOR 120 MINUTES AT 1,200°F.

American Security's BF Gun Safes use a proprietary fill material called DryLight, which offers exceptional fire protection without adding excess weight. This superior fire protection was confirmed at ETL-Intertek, the industry's leading independent laboratory for gun safe fire testing. When analyzing the fire performance

of competitive safes, be sure to weigh reports from independent laboratories against unverified factory testing or untested claims.

During fire testing, ETL-Intertek kept our BF Gun Safes in their test oven for 120 minutes. Within 8 minutes, the furnace temperature was raised to 1200° F, and that temperature was maintained for the remainder of the 120 minute test. This method is consistent with the UL-72 fire test. Typical house fires only reach temperatures of 1100° F. A safe is considered to have failed this test if temperatures exceed 350°F anywhere in the safe. Our safe passed the test as internal temperatures never exceeded 350° F during the 120 minutes of testing. Paper typically starts to ignite at 450° F.

BURGLARY RATINGS

BURGLARY RATINGS



The burglary safe Construction Ratings were established by the insurance industry to develop a standard that will indicate the degree of protection a safe will provide against an attempted burglary attack. The most common construction ratings range from B-Rate to C-Rate.

The best burglary safe Test Performance Ratings were established by Underwriters Laboratories (UL). Underwriters Laboratories was founded in 1894 and is chartered as a not-for-profit independent testing organization. U.L. has been testing products and writing standards for safety for more than a century. The most common Test Performance Ratings range from the U.L. RSC burglary rating to the U.L. TL-15, TL-30 and TL30x6 high security ratings.

B-CLASSIFICATION / GOOD PROTECTION

The "B" burglary resistive classification is an industry construction and performance rating. This type of construction rating was established by the insurance industry to develop a standard that will indicate the degree of protection a safe will provide against an attempted burglary attack.

Construction Specifications: Steel doors less than 1" thick and steel body less than ½" thick.

C-CLASSIFICATION / BETTER PROTECTION

The "C" burglary resistive classification is an industry construction and performance rating. This type of construction rating was established by the insurance industry to develop a standard that will indicate the degree of protection a safe will provide against an attempted burglary attack.

Construction Specifications: Steel doors at least 1" thick and steel body at least ½" thick.

U.L. LABEL — RESIDENTIAL SECURITY CONTAINER I

Signifies a combination-locked safe designed to offer a limited degree of protection against attack by common mechanical and electrical hand tools and any combination of these means.

Construction Requirements:

- U.L. listed Group II combination lock or Type 1 electronic lock
- Door material equivalent to at least 3/16" open hearth steel
- Body walls of material equivalent to at least 12 gauge open hearth steel

Performance Requirements: The door successfully resist entry for a net working time

of 5 minutes when attacked against rigorous prying, drilling, punching, chiseling, and tampering attacks by UL technicians.

U.L. LABEL — RESIDENTIAL SECURITY CONTAINER II

Signifies a combination-locked safe designed to offer a limited degree of protection against attack by common mechanical and electrical hand tools and any combination of these means.

Construction Requirements:

- U.L. listed Group II combination lock or Type 1 electronic lock
- Door material equivalent to at least 3/16" open hearth steel
- Body walls of material equivalent to at least 12 gauge open hearth steel

Performance Requirements: The door successfully resist entry for a net working time of 10 minutes when attacked against rigorous prying, drilling, punching, chiseling, and tampering attacks by UL technicians.

U.L. LABEL — BURGLARY CLASSIFICATION TL-15: BEST PROTECTION

Signifies a combination-locked safe designed to offer a maximum door protection against attack by common mechanical and electrical hand tools and any combination of these means.

Construction Requirements:

- U.L. listed Group 2M, 1, 1R combination lock or Type 1 electronic lock
- 750 lbs. minimum or comes with instructions for anchoring in a larger safe, concrete blocks or on the premises where used
- Body walls of material equivalent to at least 1" open hearth steel with a minimum tensile strength of 50,000 P.S.I.
- Walls fastened in a manner equivalent to continuous ¼" penetration weld of open hearth steel with minimum tensile strength of 50,000 P.S.I.
- One hole ¼" or less, to accommodate electrical conductors arranged to have no direct view of the door or locking mechanism

Performance Requirements: The door successfully resist entry* for a net working time of 15 minutes when attacked with common hand tools, picking tools, mechanical or portable electric tools, grinding points, carbide drills and pressure applying devices or mechanisms.

U.L. LABEL — BURGLARY CLASSIFICATION TL-30: SUPERIOR PROTECTION

Signifies a combination-locked safe designed to offer a maximum door protection against attack by common mechanical and electrical hand tools and any combination of these means.

Construction Requirements:

- U.L. listed Group 2M, 1, 1R combination lock or Type 1 electronic lock
- 750 lbs. minimum or comes with instructions for anchoring in a larger safe, concrete blocks or on the premises where used
- Body walls of material equivalent to at least 1" open hearth steel with a minimum tensile strength of 50,000 P.S.I.
- Walls fastened in a manner equivalent to continuous ¼" penetration weld of open hearth steel with minimum tensile strength of 50,000 P.S.I.
- One hole ¼" or less, to accommodate electrical conductors arranged to have no direct view of the door or locking mechanism

Performance Requirements: The door successfully resist entry* for a net working time of 30 minutes when attacked with common hand tools, picking tools, mechanical or portable electric tools, grinding points, carbide drills and pressure applying devices or mechanisms, abrasive cutting wheels and power saws.

U.L. LABEL — BURGLARY CLASSIFICATION TL-30x6: EXTREME PROTECTION

Signifies a combination-locked safe designed to offer a maximum six-sided body and door protection against attack by common mechanical and electrical hand tools and any combination of these means.

Construction Requirements:

- U.L. listed Group 2M, 1, 1R combination lock or Type 1 electronic lock
- 750 lbs. minimum or comes with instructions for anchoring in a larger safe, concrete blocks or on the premises where used
- Body walls of material equivalent to at least 1" open hearth steel with a minimum tensile strength of 50,000 P.S.I.
- Walls fastened in a manner equivalent to continuous ¼" penetration weld of open hearth steel with minimum tensile strength of 50,000 P.S.I.
- One hole ¼" or less, to accommodate electrical conductors arranged to have no direct view of the door or locking mechanism

Performance Requirements: The body and door successfully resist entry* for a net working time of 30 minutes when attacked with common hand tools, picking tools, mechanical or portable electric tools, grinding points, carbide drills and pressure applying devices or mechanisms, abrasive cutting wheels and power saws.

* Entry means for: Opening the door or making a 6 square inch opening entirely through the door or front face.

INDEX BY MODEL

INDEX BY MODEL NUMBER

A

ACE2020	38
ACE2020XD	38
ACE3020	38
ACFE020XD	38
ACE4024	38
ACE4024XD	38
ACE4824DS	38
ACE5024	38
ACE5024XD	38
ACE6030	38
ACE6030XD	38
ACF2020	39
ACF2020XD	39
ACF3020	39
ACF3020XD	39
ACF4024	39
ACF4024XD	39
ACF4824DS	39
ACF5024	39
ACF5024XD	39
ACF6030	39
ACF6030XD	39
AM2020E5	17
AM3020E5	17
AM4020E5	17

B

B17	23
B24	23
B1500	22
B2200	22
B2900	22
B3700	22
B5800	22
BF1512	15
BF1716	15
BF2116	15
BF3416	15
BFII6024	5
BFII6030	5
BFII6032	5
BFII6636	5
BFII7240	5
BFII7250	5
BFS912E5LP	16
BFS1512E1	16
BFS2214E1	16
BFS2815E1	16
BFS3416E1	16
BFX6024	6
BFX6030	6
BFX6032	6
BFX6636	6
BFX7240	6
BFX7250	6
BLB2018	31
BLB3018	31
BLB3024	31

BLB4024	31
BLC2018	31
BLC3018	31
BLC3024	31
BLC4024	31
Burglary Ratings	50
BWB2020	30
BWB2020FL	29
BWB2020FLNL	29
BWB3020	30
BWB3020-D1	29
BWB3020FL	29
BWB4020	30
BWB4020FL	29

C

C3	23
C5	23
C7	23
CE1814	35
CE2518	35
CE3524	35
CE4524	35
CE5524	35
CE6528	35
CE7236	35
CEV1814	36
CEV2518	36
CEV3524	36
CEV5524	36
CEV6528	36
CF1814	35
CF2518	35
CF3524	35
CF4524	35
CF5524	35
CF6528	35
CF7236	35
CFX252016	33
CFX352020	33
CFX452020	33
CFX582820	33
CFX703620	33
CSC1413	18
CSC1913	18
CSC3018	18
CSC4520	18

D

DSF2014	26
DSF2516E2	27
DSF2714	26
DSF3214	26
DSR2516E2	27
DST2014	26
DXE1414	32
DXE1818	32
DXE2020	32
DXE2420	32

DXE2424XD	32
DXE3018XD	32
DXE3024	32
DXE3030	32
DXE4024	32
DXE4524	32
DXE5030	32
DXE5224	32
DXE6030	32
DXE7234	32

E

ESL5	43
ESL10	44
ESL20	44
ESLAUDIT II	43
EST813	19
EST916	19
EST1014	19
EST2014	19

F

Fire Ratings	48
FS149E5LP	21
FS914E5LP	21
FS1814E5	21

G

Gun Safe Accessories	13
----------------------	----

H

HAS410	11
--------	----

I

IRC916E	19
Interior Drawers/Lockers	41

K

K1	25
K3	23
K5	23
K7	23
Kaba Auditcon® Lock	45

L

Lock Comparison Chart	46
Lock Index	51

M

MAX1014	37
Mechanical Locks	47
MM2820Ctr-Drop-ESLAudit	27
MM2820Top-Drop-ESLAudit	27
MM2820-Drop-ESLAudit	27
Modular Alarm	41
MS1414	30

N

NARCO3824	40
NARCO3839	40
NARCO8336	40

NF5924E5	7
NF6030E5	7
NF6032E5	7
NF6036E5	7

P

PS1208EZ	11
PS1210HD	11

R

RF703620X6	4
RF582820X6	4
RF6528	4
RMM2620ESL20-R	28
RMM2620ESLAudit II-R	28
RMM2620SW-R	28
RMM3124ESLAudit II	28
ROTOBOLT	45

S

SAFEWIZARD II®	42
SF6030E5	8
SF6032E5	8
SF6036E5	8
SF7240E5	8

T

TB0610	25
TF5517E5	9
TF5924E5	9

U

UBS648	10
UL1511	20
UL1812	20
UL1812X	20

V

VD8030BF	12
VD8030BFIS	12
VD8030BFQ	12
VD8030BFQIS	12
VD8036BF	12
VD8036BFIS	12
VD8036BFQ	12
VD8036BFQIS	12
VD8042BF	12
VD8042BFQ	12
VD8042BFIS	12
VD8042BFQIS	12

W

WEST2114	24
WFS149E5LP	24
WS1214E5	24

GUIDE TO SAFE USAGE



WHAT SAFE IS RIGHT FOR ME?

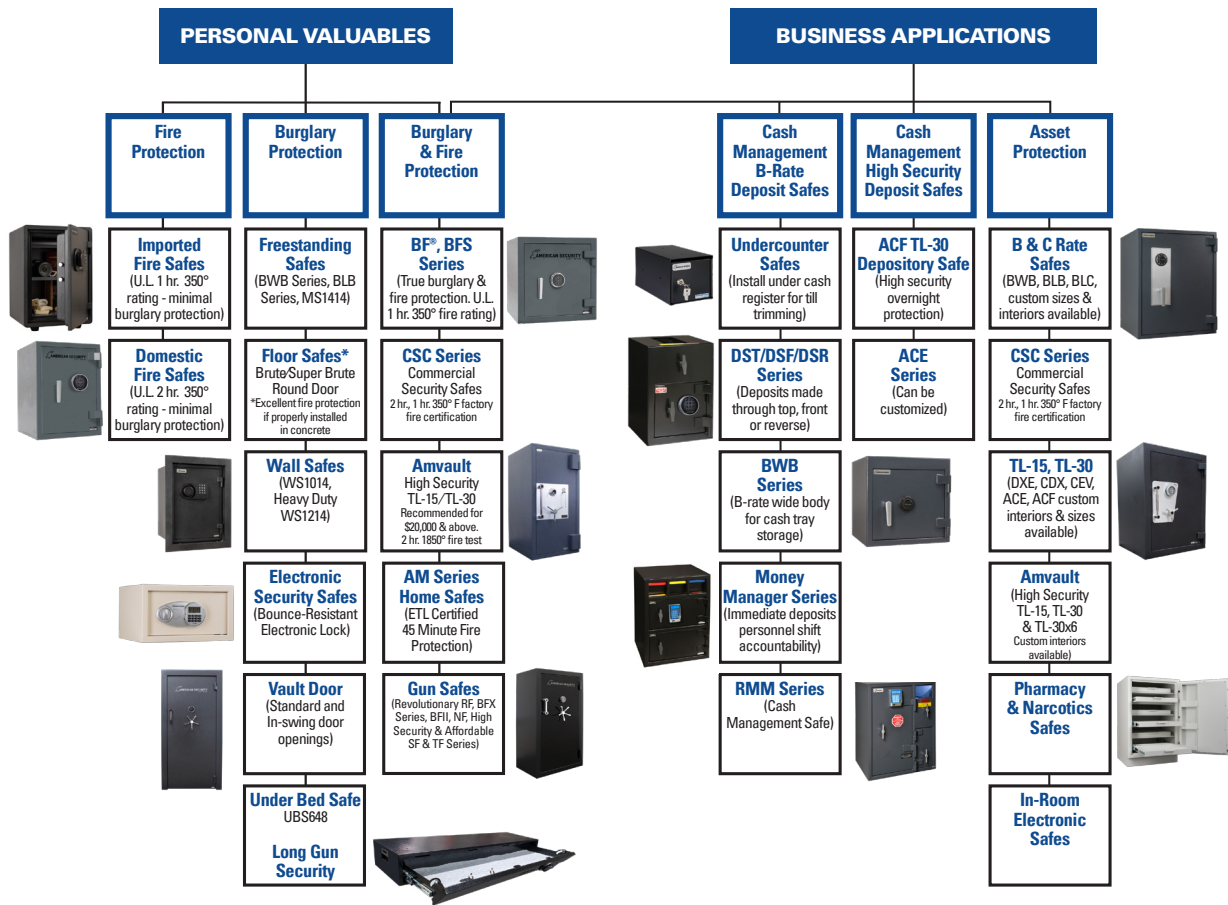

PROTECTING WHAT MATTERS MOST SINCE 1946

From day one, American Security has been dedicated to manufacturing high-quality, high-security safes. We currently offer an extensive product line of more than 400 standard models of burglary and fire-resistant safes in every insurance classification, from B-rated burglary and fire safes to UL-certified TL-15 and TL-30.

For more information about any of the safe solutions depicted here, check out our catalog or visit us on the web at: americansecuritysafes.com







75 YEARS OF AMERICAN INNOVATION

