

# 2023 Gun Safe Catalog

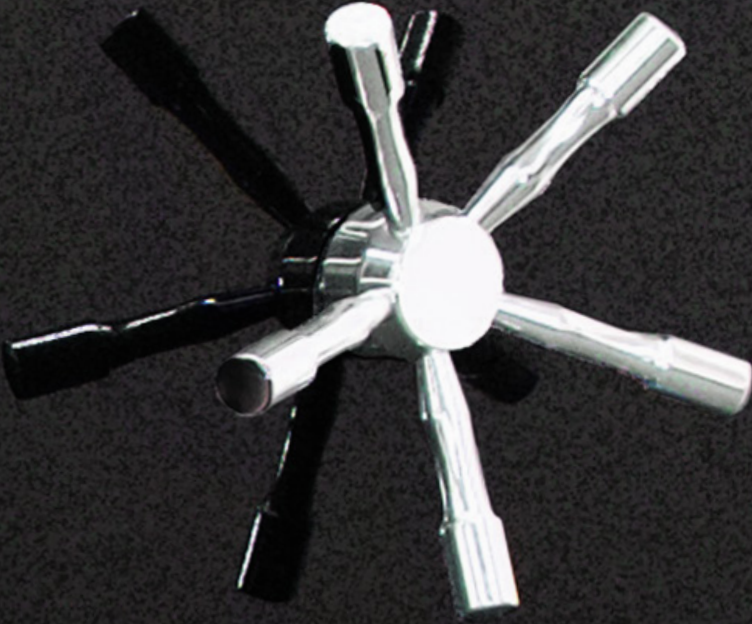

# TABLE OF CONTENTS

## **RF Series**

120 Min. Fire U.L. TL-30 and TL-30X6 .....5

## **BFII Series**

120 Min. Fire U.L. Level II Burglary .....6

## **BFX Series**

120 Min. Fire U.L. Level I Burglary .....7

## **NF Series**

90-Minute Fire U.L. Level I Burglary ..... 12

## **SF Series**

60-Minute Fire ..... 13

## **TF Series**

30-Minute Fire ..... 14

## **AM Series**

45-Minute Fire ..... 15

**Fire Safes and Electronic Safes** ..... 16

**Concealed Safe** ..... 17

**Handgun Safes** ..... 18

**Vault Doors** ..... 19

**Storage Options & Safe Cloak** ..... 20

**Electronic Locks & Other Options** ..... 21

**Gun Safes At A Glance** ..... 22

### **On the Cover:**

*BFX6636 in NEW Black Diamond Two-Tone door with  
Chrome Hardware.*



**American Security Gun Safe Lifetime Replacement Warranty**

If you are the original owner of an American Security gun safe that suffers damage due to burglary or fire, American Security will, at our discretion, either repair your safe or replace it with a current production model of comparable value.

**No-Cost Burglary Warranty**  
If your American Security gun safe is forcibly entered, we will repair or replace your safe free of charge.

**No-Cost Attempted Burglary Warranty**  
If your American Security gun safe has been subject to an attempted burglary and undergone a drill, punch or pry attack but was not forcibly entered, we will repair or replace your safe free of charge.

**No-Cost Fire Warranty**  
If your American Security gun safe has been subject to a home fire, we will repair or replace your safe free of charge.

This certificate only highlights certain terms of American Security's warranty. The complete terms of our warranty can be found on our website at [www.americansecuritysafes.com](http://www.americansecuritysafes.com).

# WE STAND BEHIND OUR CRAFTSMANSHIP WITH A "NO COST" LIFETIME WARRANTY AGAINST THEFT & FIRE

American Security® manufactures safes with the best fire and burglary protection in the industry. We're so confident in our products, that we offer a lifetime warranty on all our gun safes. Our warranty covers:



- Burglaries – If your safe is forcibly entered, we will repair or replace it free of charge.
- Attempted Burglaries – If your safe undergoes a drill, punch or pry attack and is not breached, we will repair or replace it free of charge.
- Damage from a Home Fire – If your safe is damaged in a home fire, we will repair or replace it free of charge.

At no cost to you, we will either repair your damaged gun safe or replace it with a current production model of comparable value.<sup>1</sup>



## STANDARDIZED TESTING FROM INDEPENDENT LABORATORIES

American Security is one of the first manufacturers in the gun safe industry to use standardized test procedures from independent laboratories to substantiate our burglary and fire ratings. Standardized independent testing provides consistent test procedures that can be used across the industry so consumers can meaningfully compare ratings between different safes when making a purchasing decision.



## BURGLARY RATINGS

In the United States, the most recognized testing organization for burglary resistance of safes is Underwriters Laboratories (UL). UL publishes standards and administers tests to check if products meet those standards. Standards include specific tools that are used during a break-in attempt and a specific time limit for the test. There are several different burglary classifications that establish specific levels of attack resistance. The most common listing in the gun safe industry is Residential Security Container (RSC).

## FIRE RATINGS

The ETL logo on our fire-rating labels indicates that our ratings have been verified by independent testing at Intertek Laboratories. Intertek is a multinational independent inspection, product testing and certification organization with over 38,000 employees in over 100 countries. To test our products, Intertek places our safes in a furnace with 8 gas burners. The test furnaces reach 1200°F in 8 minutes. That temperature is maintained for the duration of the test. Five separate thermocouples monitor the temperature inside the safe. To pass Intertek's test, the internal temperature inside a safe must remain below 350°F. Paper burns at approximately 450°F.

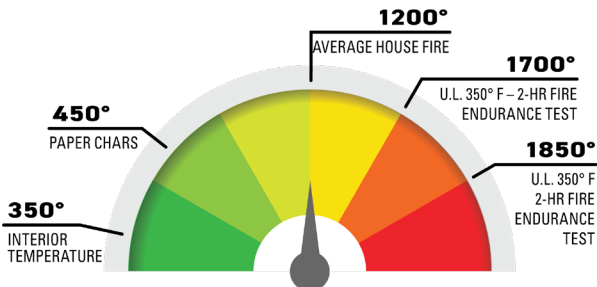

Series	Fire Label	Outside Temp	Time Period	Inside Temp Less Than
RF Series	120	1800°F	120 min.	350°F
BFI/ BFX Series	ETL 120	1200°F	120 min.	350°F
NF Series	ETL 90	1200°F	90 min.	350°F
SF Series	ETL 60	1200°F	60 min.	350°F
TF Series	30	1200°F	30 min.	350°F

<sup>1</sup> To file a claim, you must be the original owner of the American Security Gun Safe. Within 30 days of the burglary/fire incident, you must properly file a police report documenting the incident. A copy of the police report must be submitted to American Security with your warranty claim.

# RF SERIES - 120 MINUTE FIRE

## U.L. LISTED HIGH SECURITY SAFE



*RF582820X6 in textured black with chrome hardware, combo lock, and right-swing door.*

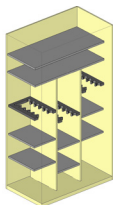

**RF703620X6**  
Interior

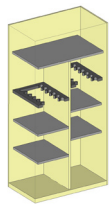

**RF582820X6**  
Interior



**RF6528**  
Interior

### SECURITY

- 6" Thick High Security Composite Door
- 3½" Thick High Security Body (3" on X6)
- UL Listed TL - 30 or TL - 30X6 High Security Burglary Classification
- Active 3-Way Bolt Work Available
- 10 Massive 1½" Chrome Plated Bolts
- Anchor Holes Provided

### FIRE PROTECTION

- Seamless High Security Composite Fill
- 120-Minute Verified Fire Rating
- Paulosol Seals to Protect Against Fire and Smoke

### FUNCTIONALITY

- Industry's Most Flexible Interior
- Door Organizer
- Storage for up to Two Long Guns on Door

### TEXTURED COLORS



Sandstone

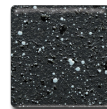

Granite



Black

### HARDWARE COLORS



Chrome



Brass



Black Nickel

### RF SPECIFICATIONS

Model	Outside Dim H x W x D	Interior Capacity	Door Clearance	Weight Lbs.	Door Thickness	Available Locks
<b>RF703620X6</b>	76" x 42" x 29-¼"	12-12-12-24-36+2 Gun or 58 + 2 Gun	70" x 36"	4,578	6"	See Page 24
<b>RF582820X6</b>	64" x 34" x 29-¼"	12-12-24 + 2 Gun	58" x 28"	3,455	6"	See Page 24
<b>RF6528</b>	72" x 35" x 29-¼"	12-12-24 + 2 Gun	65" x 28"	3,418	6"	See Page 24

# BFII SERIES - 120 MINUTE FIRE

## U.L. LISTED LEVEL II BURGLARY



**BFII6030**  
Shown in High Gloss Black Onyx with Chrome Hardware, ESL10 and logo, and optional finials

### BFII SERIES CONSTRUCTION

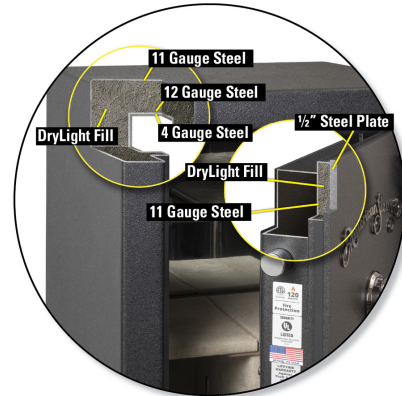

#### BFII GUN SAFES:

1/8" OUTER STEEL LINER WITH 5/16" INNER STEEL LINER PROVIDING A NEAR TOTAL 1/2" THICK STEEL BARRIER FOR ADDED BURGLARY PROTECTION



### SECURITY

- 1/2" solid steel plate door
- 2-1/4"-Thick Body with 1/8" outer shell and 5/16" thick inner liner
- Combined steel thickness of 1/2" in body construction
- UL Level II RSC Burglary Classification (2-Man team, 10-minute test. Utilizes same tools as a TL-15)
- American Security's Patented Active Hardplate
- TL-15 boltwork with 10 massive 1-1/2" Chrome Plated Bolts
- Anchor Holes Provided

### WARRANTY

- 5-year parts and labor warranty when purchased with a factory installed American Security lock.
- Special lifetime warranty for damage from burglary attempts and fire.

### FIRE PROTECTION

- Seamless DryLight® Fill
- 120-Minute Intertek Verified Fire Rating
- Dual Door Seals to Protect Against Fire and Smoke

### FUNCTIONALITY

- Industry's Most Flexible Interior
- Door Organizer
- Storage for Long Guns on Door
- Spy-proof, key-locking dial with decorative five-spoke handle and a convenient pull handle. (BFII6024 offers an "L" handle and does not come with a pull handle).
- Mirrored Back Wall for Added Interior Visibility
- AC Power Outlet with Removable Cord
- LED Light Kit

### BFII SPECIFICATIONS

Model	Outside Dim H x W x D	Interior Capacity	Door Clearance	Weight Lbs.	Door Thickness	Available Locks
<b>BFII7250</b>	71-1/4" x 50" x 28"	14-14-14-28-48+2 Gun or 73 + 2 Gun	63-3/4" x 45-5/16"	2,438	4-3/4"	See Page 23
<b>BFII7240</b>	71-1/4" x 40" x 26"	12-12-12-24-36 + 2 Gun or 58 + 2 Gun	63-3/4" x 32-5/16"	1,991	4-3/4"	See Page 23
<b>BFII6636</b>	65-1/4" x 36" x 26"	12-12-24 + 2 Gun	57" x 28-1/2"	1,716	4-3/4"	See Page 23
<b>BFII6030</b>	59-1/4" x 30" x 26"	11-11-22 + 2 Gun	51-3/4" x 22-5/16"	1,395	4-3/4"	See Page 23
<b>BFII6032</b>	59-1/4" x 30" x 21"	9-9-18 + 2 Gun	51" x 22-5/16"	1,244	4-3/4"	See Page 23
<b>BFII6024</b>	59-1/4" x 24" x 21"	8-8-16 Gun + 1 Gun	51" x 16-5/16"	1,067	4-3/4"	See Page 23

# BFX SERIES - 120 MINUTE FIRE

## U.L. LISTED LEVEL I BURGLARY SAFE



**BFX6636** in NEW Black Diamond Two-Toned with chrome hardware, ESL10 electronic lock, and Right swing door.

### SECURITY

- ½"-Thick Steel Plate Door (BFX7250 & BFX6024 have 3/8" steel plate)
- Four-Way Active Bolt Work (BFX6024 has Two-Way Bolt Work)
- Active 4x Locking System (See Page 6 for Details)
- 2"-Thick Body
- UL Level I RSC Burglary Classification
- Massive 1-½" Chrome Plated Bolts
- Anchor Holes Provided

### WARRANTY

- 5-year parts and labor warranty when purchased with a factory installed American Security® lock.
- Special lifetime warranty for damage from burglary attempts and fire.

### FIRE PROTECTION

- Seamless DryLight® Fill
- 120-Minute Intertek Verified Fire Rating
- Dual Door Seals to Protect Against Fire and Smoke

### FUNCTIONALITY

- Industry's Most Flexible Interior
- Door Organizer
- Storage for up to Two Long Guns on Door
- Spy-proof, key-locking dial with decorative five-spoke handle and a convenient pull handle. (BFX6024 offers a three-spoke handle and does not come with a pull handle).
- AC Power Outlet with Removable Cord
- LED Light Kit

# BFX SERIES CONSTRUCTION

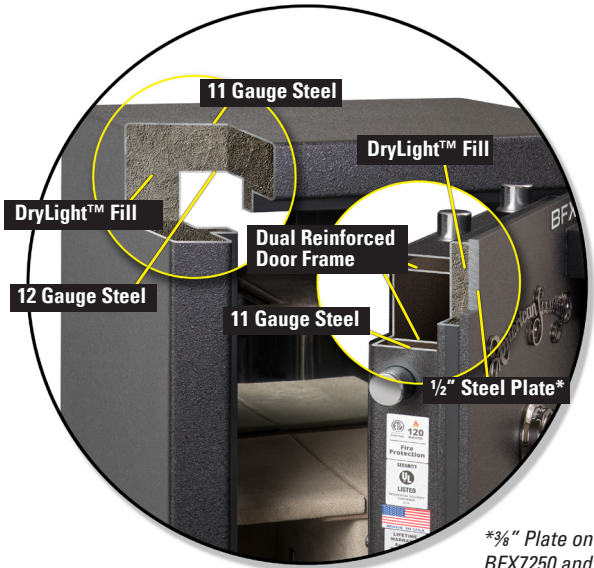

*\*3/8\"* Plate on  
BFX7250 and  
BFX6024

**BFX GUN SAFES:  
11 GA OUTER STEEL LINER WITH  
12 GA INNER STEEL LINER  
TOTALING APPROX. 1/4\"** STEEL BARRIER



*BFX6032 shown with NEW eagle logo door organizer*



## BFX SPECIFICATIONS

Model	Outside Dim H x W x D	Interior Capacity	Door Clearance	Weight Lbs.	Door Thickness	Available Locks
<b>BFX7250</b>	71-1/4" x 50" x 28"	14-14-14-28-48+2 Gun or 73 + 2 Gun	63-3/4" x 45-5/16"	1,789	4-5/8"	See Page 23
<b>BFX7240</b>	71-1/4" x 40" x 26"	12-12-12-24-36 + 2 Gun or 58 + 2 Gun	63-3/4" x 32-5/16"	1,585	4-3/4"	See Page 23
<b>BFX6636</b>	65-1/4" x 36" x 26"	12-12-24 + 2 Gun	57" x 28-1/4"	1,319	4-3/4"	See Page 23
<b>BFX6030</b>	59-1/4" x 30" x 26"	11-11-22 + 2 Gun	51-3/4" x 22-5/16"	1,036	4-3/4"	See Page 23
<b>BFX6032</b>	59-1/4" x 30" x 21"	9-9-18 + 2 Gun	51" x 22-5/16"	913	4-3/4"	See Page 23
<b>BFX6024</b>	59-1/4" x 24" x 21"	8-8-16 Gun + 1 Gun	51" x 16-5/16"	720	4-5/8"	See Page 23



# BFX SERIES ACTIVE 4X LOCKING SYSTEM

BUILT WITH UNBEATABLE SECURITY FEATURES THAT KEEP BURGLARS OUT!



Deadlocks all four sides



• ¼" hard plate • relocker pin • gear cam housing



Gear drive mechanism with 360° handle rotation



Protection from severe sledgehammer attacks



Pry-resistant dual reinforced steel door frame



## PRY-RESISTANT DUAL REINFORCED STEEL DOOR FRAME

Protects the heart of the Active 4x locking mechanism from severe pry attacks.



## DRILL ATTACK PROTECTION

- ¼" hardplate and a top-rated hardened disc defeats lock attacks
- Spring loaded relock mechanism
- Gear cam housing with precision engineered lock bolt protection

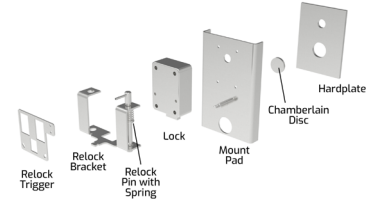

## GEAR-DRIVEN BOLTWORK WITH 360° HANDLE ROTATION

Drives the industry's longest solid steel locking bolts deep into the body of the safe protecting the safe against severe pry attacks.



## SLEDGEHAMMER IMPACT-RESISTANT BOLTWORK

Protects the heart of the Active 4x locking mechanism from severe sledgehammer attacks.

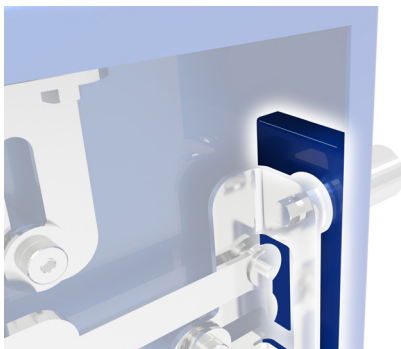

# BFX AND BFII SERIES

## WHAT IS DRYLIGHT®?

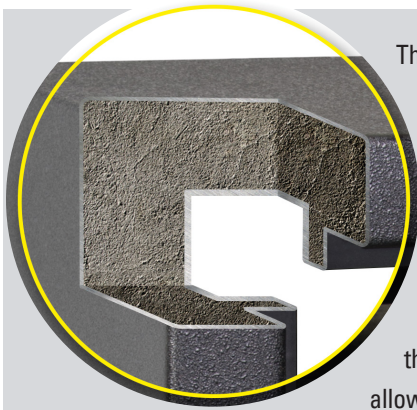

The American Security® BF® Gun Safes are the best gun safe available today. For burglary protection, it has a massive ½"-thick steel plate in the door. For fire protection, it is filled with our revolutionary DryLight.

For many years, smaller fire safes have been constructed with a poured fill material. But larger gun safes pose several manufacturing challenges when it comes time to fill them with insulating materials. Because of this, the industry adopted the use of drywall as the primary material for fire protection. The problem with using drywall is that no matter how much care is taken in assembling the many pieces of drywall into the safe body, gaps and joints still remain in the construction that can allow heat to penetrate the safe body. American Security was able to overcome this technical challenge by developing manufacturing processes that allow us to produce a safe body filled with the seamless DryLight fire barrier. Independent testing at Intertek Laboratories has confirmed that these safes outperform gun safe bodies constructed with drywall.

## BFX/BFII BURGLARY RATINGS COMPARISON

BFX Gun Safes - RSC Level I (1-Man, 5 minute test. Utilizes tools typically found in a household)	BFII Gun Safes - RSC Level II (2-man Team, 10 minute test. Utilizes same tools as a TL-15 test)
1/4" Dia. Punch	1/2" Dia. Punch
Sledge Hammer 3 lb.	Sledge Hammer 10 lb.
Crow Bar, 18"	Pry Bar, 6 ft.
Chisel 1/2"	Chisel 1" Wide x 12" L
Screw Driver 18	Screw Driver 18
1/4" Drill Bits	1/2" Drill Bits
3/8" Drill	1/2" HD Drill
	Pick, 30"
	Axe, 35"
	4" Conic Punch
	Hole Saw, 3" Carbide
	Pin Hammer
	Wedge, Log Splitting
	Punch/Chisel Holder

RSC LEVEL I TOOL COMPLEMENT

RSC LEVEL II TOOL COMPLEMENT



# BFX AND BFII SERIES

## COLOR OPTIONS AND INTERIOR OPTIONS



**BFX6030** Shown in High gloss Onyx with Chrome Hardware, ESL10 and logo.



**BFX6030** Shown in High Gloss Lazer Red with Brass Hardware, ESL10 and logo, and optional finials



**BFX6032** Shown in High Gloss Pearl Essence with Black Nickel Hardware, ESL10 and logo, and optional finials

NOTE: All models available with optional finials in all hardware colors

### HIGH GLOSS COLORS



Burnt Orange



Charcoal Metallic



Lazer Red



Onyx



Pearl Essence



Platinum Metallic

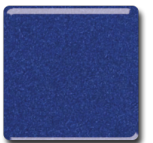

Sapphire Blue

### TEXTURED COLORS



Sandstone

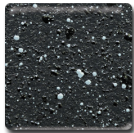

Granite



Black



Black Diamond/Black



Onyx/Black

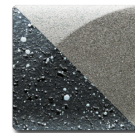

Charcoal/Granite

### HIGH GLOSS/TEXTURE COLORS

### HARDWARE COLORS



Chrome



Brass



Black Nickel

### BFX/BFII INTERIOR CONFIGURATIONS

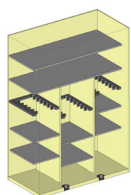

7250 Standard Gun Interior

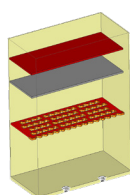

7250 Optional 73 Gun Interior

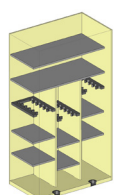

7240 Standard Gun Interior

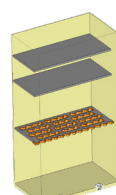

7240 Optional 58 Gun Interior

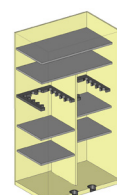

6636 Standard Gun Interior

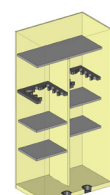

6030 Optional Gun Interior

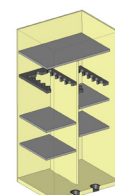

6032 Standard Gun Interior

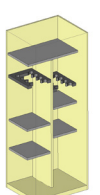

6024 Optional Gun Interior

# NF SERIES - 90 MINUTE FIRE

## U.L. LISTED LEVEL I BURGLARY

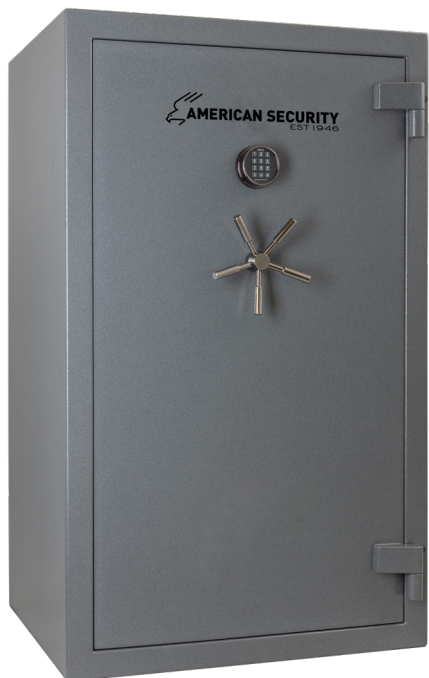

NF6036E5

The American Security® NF Gun Safe offers both superior performance and value. For burglary protection, it has a stout ¼" -thick steel plate door. For fire protection, it is lined with three to four layers of drywall that are strategically engineered for optimal fire protection. This enables the NF Gun Safe to pass a verified 90-minute fire test at Intertek, an independent testing laboratory.

### SECURITY

- ¼"-Thick Steel Plate Door
- 11-Gauge Steel Body
- UL Level I RSC Burglary Classification (1-Man, 5-minute test. Utilizes tools typically found in a household)
- 14 Massive 1-½" Chrome Plated Bolts
- Anchor Holes Provided
- U.L. Listed ESL5 Electronic Lock with Illuminated Keypad

### FIRE PROTECTION

- Lined with Three Layers of Drywall
- 90-Minute Intertek Verified Fire Rating
- Dual Door Seals to Protect Against Fire and Smoke

### FUNCTIONALITY

- Industry's Most Flexible Interior
- Door Organizer
- Storage for up to Two Long Guns on Door
- AC Power Outlet with removable cord

### NF SERIES CONSTRUCTION

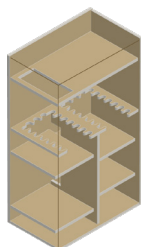

NF6036E5  
Standard Interior

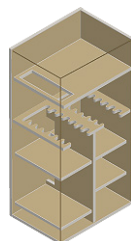

NF6030E5  
Standard Interior

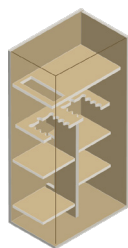

NF6032E5  
Standard Interior

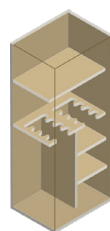

NF5924E5  
Standard Interior

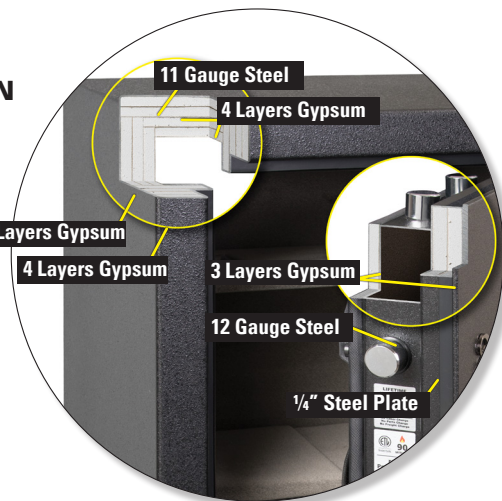

### COLOR & HARDWARE

NOTE: NF Series Safes are only available in Textured Gunmetal Gray with Black Nickel Hardware



Gunmetal Gray



Black Nickel

### NF SPECIFICATIONS

Model	Outside Dim H x W x D	Interior Capacity	Door Clearance	Weight Lbs.	Door Thickness	Available Locks
NF6036E5	59" x 36" x 26"	17-17-34+2 Gun	52" x 28-¾"	977	4-¼"	ESL5
NF6030E5	59" x 30" x 26"	14-14-28 + 2 Gun	52" x 22-¾"	788	4-¼"	ESL5
NF6032E5	59" x 30" x 21"	9-9-18 + 2 Gun	52" x 22-¾"	761	4-¼"	ESL5
NF5924E5	59" x 24" x 18"	8-8-16 + 2 Gun	52" x 16-¾"	600	4-¼"	ESL5

# SF SERIES – 60 MINUTE FIRE



SF6032E5

The American Security® SF gun safe offers both performance and value. For burglary protection, it has a stout 3/16" - thick steel plate door. For fire protection, it is lined with three to four layers of drywall that are strategically engineered for optimal fire protection. This enables the SF Gun Safe to pass a verified 60-minute fire test at Intertek, an independent testing laboratory.

## SECURITY

- 3/16" - Thick Steel Plate Door
- Four-Way Bolt Work
- 12-Gauge steel body
- 14 1-1/4" Chrome Plated Bolts
- Anchor Holes Provided
- U.L. Listed ESL5 Electronic Lock with Illuminated Keypad

## FIRE PROTECTION

- Lined with three layers of drywall
- 60-Minute Intertek Verified Fire Rating
- Dual Door Seals to Protect Against Fire and Smoke

## FUNCTIONALITY

- Industry's Most Flexible Interior
- Door Organizer
- Storage for up to Two Long Guns on Door

## SF SERIES CONSTRUCTION

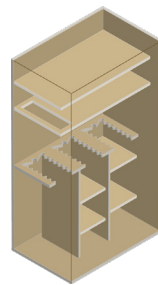

SF7240E5  
Standard Interior

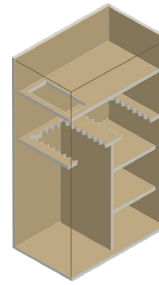

SF6036E5  
Standard Interior

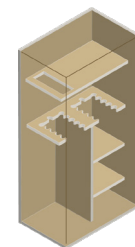

SF6032E5  
Standard Interior

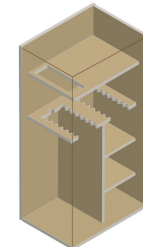

SF6030E5  
Standard Interior

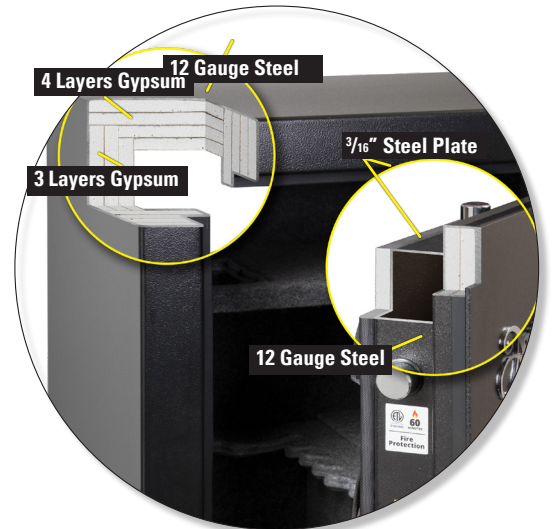

## COLOR & HARDWARE

NOTE: SF Series Safes are only available in Textured Black with Black Nickel Hardware



Black



Black Nickel

## SF SPECIFICATIONS

Model	Outside Dim H x W x D	Interior Capacity	Door Clearance	Weight Lbs.	Door Thickness	Available Locks
SF7240E5	72" x 40" x 26"	15-15-15-30-45 + 2 Gun	63-3/4" x 45-5/16"	1,086	4-3/4"	ESL5
SF6036E5	59" x 36" x 26"	17-17-34 + 2 Gun	63-3/4" x 32-5/16"	840	4-3/4"	ESL5
SF6030E5	59" x 30" x 26"	15-15-30 + 2 Gun	57" x 28-3/4"	748	4-3/4"	ESL5
SF6032E5	59" x 30" x 21"	11-11-22 + 2 Gun	51-3/4" x 22-5/16"	662	4-3/4"	ESL5

# TF SERIES - 30 MINUTE FIRE

The American Security® TF Gun Safe offers economic trusted protection. For burglary protection, it has a stout 3/16"-thick steel plate door. For fire protection, it is lined with drywall that is strategically engineered for 30 minutes of fire protection.

## SECURITY

- 3/16"-Thick Steel Plate Door
- Four-Way Bolt Work
- 14-Gauge Steel Body
- 14 1-1/4" Chrome Plated Bolts on TF5924E5
- 8 1" Chrome Plated Bolts on TF5517E5
- Anchor Holes Provided
- U.L. Listed ESL5 Electronic Lock with Illuminated Keypad

## FIRE PROTECTION

- Lined with Two Layers of Drywall on the Ceiling and Door
- Lined with One Layer of Drywall in All the Walls
- 30-Minute Factory Label
- Dual Door Seals to Protect Against Fire and Smoke

## FUNCTIONALITY

- Industry's Most Flexible Interior
- Door Organizer
- TF5924 has Storage for One Long Gun on the Door



TF5924E5

## TF SERIES CONSTRUCTION

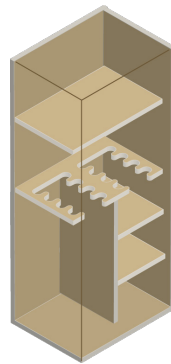

TF5924E5 Standard Gun Interior

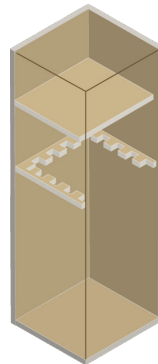

TF5517E5 Standard Gun Interior

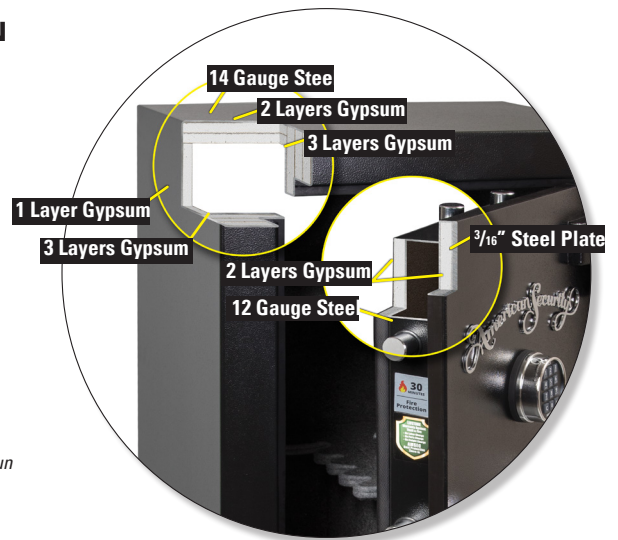

## COLOR & HARDWARE

NOTE: TF Series Safes are only available in Textured Black with Black Nickel Hardware



Black



Black Nickel

## TF SPECIFICATIONS

Model	Outside Dim H x W x D	Interior Capacity	Door Clearance	Weight Lbs.	Door Thickness	Available Locks
TF5924E5	59" x 24" x 18"	8-8-16 Gun + 1 Gun	52" x 28-3/4"	388	4-1/4"	ESL5
TF5517E5	55-1/4" x 17-3/4" x 16"	11 Gun	52" x 22-3/4"	286	4-1/4"	ESL5

# AM SERIES HOME SAFES



Shown:  
AM2020E5



AM3020E5

AM4020E5



## FEATURES:

- Powder-Coated Blue with Black Nickel Hardware
- Gray Fabric Interior
- Backlit U.L.-Listed ESL5 Electronic Lock
- 12-Gauge Steel Body
- Drywall Lined
- 45-Minute ETL Verified Fire Rating
- Three-Way Bolt Work
- 4 Pre-Cut Anchor Holes
- 1 Year Parts and Labor Warranty



## AM SPECIFICATIONS

Model	Outside Dimensions	Inside Dimensions	Cu. In.	Weight. Lbs.	Shelves	Available Locks
AM2020E5	20" x 20" x 20"	17-¼" x 17-¼" x 14"	4,166	180	1	ESL5
AM3020E5	30" x 20" x 20"	27-¼" x 17-¼" x 14"	6,581	230	2	ESL5
AM4020E5	40" x 20" x 20"	37-¼" x 17-¼" x 14"	8,996	316	3	ESL5



# FIRE SAFES

THE ONLY UL-RATED 1-HOUR IMPORTED RESIDENTIAL FIRE SAFES WITH HIGH SECURITY, BOUNCE-RESISTANT LOCKS

American Security®'s 1-Hour Fire Safes are the only UL listed 1-hour fire safe offering a UL listed electronic lock. These locks offer far greater security than the locks offered on any other 1-hour fire safe.



**FS914E5LP**



**FS149E5LP**



**FS1814E5**

## FEATURES:

- UL 350°F 1-Hour Fire Rating
- UL Listed Type 1 Electronic Lock
- Backlit Keypad
- Black Granite Textured Finish
- 1 Year Parts and Labor Warranty

## FS SPECIFICATIONS

Model	Inside Dimensions	Outside Dimensions	Clear Door	Cu. In.	Weight. Lbs.	Available Locks
<b>FS914E5LP</b>	9-3/4 x 15-1/4 x 9-7/8	14 x 19-1/2 x 15-3/8	9-3/4 x 15-1/4	1,438	96	ESL5LP
<b>FS149E5LP</b>	15-1/4 x 9-3/4 x 9-7/8	19-1/2 x 14 x 15-3/8	15-1/4 x 9-3/4	1,468	96	ESL5LP
<b>FS1814E5</b>	18-1/4 x 13-1/8 x 12-3/8	23-3/4 x 18-7/8 x 18-1/2	18-1/4 x 13-1/8	2,964	164	ESL5

# ELECTRONIC SAFES



**EST813**



**EST916**



**EST1014**



**EST2014**



## FEATURES:

- 14-Gauge Steel Body
- DL6000 Electronic Lock
- LCD Display
- Pry-Resistant Recessed Door
- Internal Hinges
- 1 Year Parts and Labor Warranty
- Bounce-Resistant Lock Design

## EST SPECIFICATIONS

Model	Inside Dimensions	Outside Dimensions	Clear Door	Cu. In.	Weight. Lbs.	Available Locks
<b>EST813</b>	7-11/16 x 12-1/16 x 5-3/8	7-7/8 x 12-1/4 x 8	5-3/4 x 8-1/4	499	16	DL600
<b>EST916</b>	8-13/16 x 15 13/16 x 11-1/8	9 x 16 x 13-1/4	6-3/4 x 12-1/8	1,550	27	DL600
<b>EST1014</b>	9-9/16 x 13-15/16 x 7-3/4	9-3/4 x 14-1/8 x 9-3/4	7-5/8 x 10-1/4	1,032	22	DL600
<b>EST2014</b>	19-9/16 x 13-9/16 x 10	19-3/4 x 13-3/4 x 12-1/4	17-1/8 x 9-1/4	2,602	40	DL600



# CONCEALED SAFE



## PUTS HOME SECURITY WHERE YOU NEED IT

American Security's UBS648 has been dramatically improved since the development of our original Defense Vault (DV652). Still a secure and easy-to-conceal security container for gun storage, the UBS648 features an ultra slim profile just six inches tall, able to fit under most beds or the back of an SUV. Four mounting holes on both the top and the bottom of the unit make it possible to secure it to the floor, or undermount it to your bed frame or other surface. The UBS648's new centrally located digital keypad and tilt-out tray design makes accessing contents even easier.



**Features the U.L. Listed ESL5LP Illuminated Electronic Lock**

### FEATURES

- UL Listed ESL5-LP Electronic lock with backlit and stealth mode keypad
- 18-Gauge & 7-Gauge steel construction
- 4-Point Locking Bar
- Mini flashlight with flashlight holder
- 4 Mounting Holes on Both the Top and Bottom of safe
- Tilt-out door for easy access



### UBS SPECIFICATIONS

Model	Outside Dimension	Tray Size	Weight. Lbs.	Available Locks	Warranty
<b>UBS648</b>	6" x 48" x 14-5/8"	3-1/2" x 44-1/2" x 13-1/2"	80	ESL5-LP	1 Year Parts & Labor

# HANDGUN SAFES



	<b>PS1210HD</b>	<b>PS1208EZ</b>	<b>HAS410</b>
<b>Type</b>	Portable	Portable	Hide-a-Safe
<b>Exterior Dimension</b>	10-1/4" x 12-1/2" x 4-1/4"	8-1/8" x 12-1/4" x 4"	12" x 10" x 4"
<b>Weight Lbs.</b>	24	11	20
<b>Body</b>	10 ga. Solid Steel	14 ga. Solid Steel	10 ga. Solid Steel
<b>Door</b>	3/16" Solid Steel	14 ga. Solid Steel	3/16" Solid Steel
<b>Lock</b>	Simplex Mechanical Push Button	Simplex Mechanical Push Button	Simplex Mechanical Push Button
<b>Locking Bolt</b>	1-1/2" x 1/2" Solid Steel Block	1-1/2" x 1/2" Solid Steel Block	1-1/2" x 1/2" Solid Steel Block
<b>Lock Protection</b>	Solid Steel Lock Housing	Solid Steel Lock Housing	Solid Steel Lock Housing
<b>Interior</b>	High Density Pluck Foam	High Density Pluck Foam	High Density Pluck Foam
<b>Finish</b>	Granite Textured	Charcoal Gray	Granite Textured
<b>Carry Handle</b>	Chrome Plated Collapsible	Chrome Plated Collapsible	Solid Steel Fixed
<b>Anchor Holes</b>	4	4	4 (Top & Bottom)
<b>Origin</b>	China	China	China



# VAULT DOORS

TURN YOUR ENTIRE ROOM INTO A SECURITY VAULT

American Security® Vault Doors offer the same protection as our innovative BF® Gun Safes. They are designed to fit standard 80" x 30", 80" x 36" and 80" x 42" door openings. With our inward-swinging vault door option, your vault room can also serve as a storm shelter. The vault door's inward swing ensures that you will be able to open the door even if debris has fallen on the other side. All American Security vault doors can be opened from the inside, ensuring personal safety.

## STANDARD FEATURES

- 2" Thick Door
- 10 1-1/2" Chrome Plated Bolts (5 bolts on inswing doors)
- Adjustable Frame to Fit Walls Ranging From 4 3/4" to 9-1/2" Thick
- Safety Lock Release
- Spy-proof, key-locking dial with decorative five-spoke handle and a convenient pull handle.
- 1 Year Parts and Labor Warranty

## BF SERIES VAULT DOOR FEATURES

- 1/2" Steel Plate on Face of Door
- 1 3/8" of Seamless Drylight® as Fire Protection

## BFQ SERIES VAULT DOOR FEATURES

- 1/4" Steel Plate on Face of Door
- 1 5/8" of Seamless Drylight as Fire Protection

## OPTIONS

- Left-Swing Door Available

VD8030BFQ / VD8036BFQ / VD8042BFQ

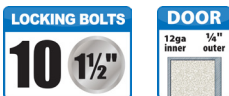

VD8030BF / VD8036BF / VD8042BF

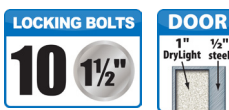

## COLOR OPTIONS



## HARDWARE OPTIONS

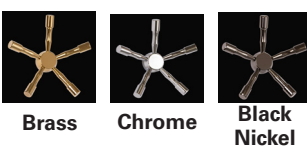

## VAULT DOOR SPECIFICATIONS

Model	Wall Dims.	Door Dims.	Weight Lbs	Available Locks
VD8030BF	79-1/2" x 29-1/2"	77-1/2" x 24-3/4"	695	LP Rotobolt Redundant Lock, Combination Lock with Key-Locking Spy-Proof Dial, Combination Lock with Spy-Proof Dial, ESL5, ESL10
VD8030BFQ	79-1/2" x 29-1/2"	77-1/2" x 24-3/4"	506	LP Rotobolt Redundant Lock, Combination Lock with Key-Locking Spy-Proof Dial, Combination Lock with Spy-Proof Dial, ESL5, ESL10
VD8030BFIS	79-1/2" x 29-1/2"	77" x 20-3/8"	672	LP Rotobolt Redundant Lock, Combination Lock with Key-Locking Spy-Proof Dial, Combination Lock with Spy-Proof Dial, ESL5, ESL10
VD8036BF	79-1/2" x 35-1/2"	77-1/2" x 31"	819	LP Rotobolt Redundant Lock, Combination Lock with Key-Locking Spy-Proof Dial, Combination Lock with Spy-Proof Dial, ESL5, ESL10
VD8036BFQIS	79-1/2" x 29-1/2"	77" x 20-3/8"	480	LP Rotobolt Redundant Lock, Combination Lock with Key-Locking Spy-Proof Dial, Combination Lock with Spy-Proof Dial, ESL5, ESL10
VD8036BFQ	79-1/2" x 35-1/2"	77-1/2" x 31"	592	LP Rotobolt Redundant Lock, Combination Lock with Key-Locking Spy-Proof Dial, Combination Lock with Spy-Proof Dial, ESL5, ESL10
VD8036BFIS	79-1/2" x 35-1/2"	77" x 26-1/4"	792	LP Rotobolt Redundant Lock, Combination Lock with Key-Locking Spy-Proof Dial, Combination Lock with Spy-Proof Dial, ESL5, ESL10
VD8036BFQIS	79-1/2" x 35-1/2"	77" x 26-1/4"	556	LP Rotobolt Redundant Lock, Combination Lock with Key-Locking Spy-Proof Dial, Combination Lock with Spy-Proof Dial, ESL5, ESL10
<b>NEW!</b> VD8042BF	79-1/2" x 41-1/2"	77-1/2" x 37"	943	LP Rotobolt Redundant Lock, Combination Lock with Key-Locking Spy-Proof Dial, Combination Lock with Spy-Proof Dial, ESL5, ESL10
<b>NEW!</b> VD8042BFQ	79-1/2" x 41-1/2"	77-1/2" x 37"	678	LP Rotobolt Redundant Lock, Combination Lock with Key-Locking Spy-Proof Dial, Combination Lock with Spy-Proof Dial, ESL5, ESL10
<b>NEW!</b> VD8042BFIS	79-1/2" x 41-1/2"	77" x 32-1/4"	912	LP Rotobolt Redundant Lock, Combination Lock with Key-Locking Spy-Proof Dial, Combination Lock with Spy-Proof Dial, ESL5, ESL10
<b>NEW!</b> VD8042BFQIS	79-1/2" x 41-1/2"	77" x 32-1/2"	632	LP Rotobolt Redundant Lock, Combination Lock with Key-Locking Spy-Proof Dial, Combination Lock with Spy-Proof Dial, ESL5, ESL10

# StorIt-Cabinets

These elegant, well-appointed 2-drawer and 4-drawer interior chests are the most sophisticated way to store and display your jewelry collection and letter files. These stunning chests are finely crafted with solid-wood maple drawer fronts and maple veneer and finished in a rich honey maple stain. Recessed door pulls give these cabinets a more streamlined appearance and makes for an easier fit into a variety of American Security® safes. All drawers are elegantly lined in a silky, dark red felt and include a variety of StorIt Jewelry Organizer Inserts.



## TWO-DRAWER CABINET

Top drawer includes a Three Compartment Ring Organizer and a Seven Compartment Jewelry Organizer. Bottom drawer can be used for bulky items or as a file drawer.

## FOUR-DRAWER CABINET

Top drawer includes a Three Compartment Ring Organizer and a Seven Compartment Jewelry Organizer. Drawer Two Includes a

Three Compartment Necklace Organizer. Drawer Three Includes a Four Compartment Watch Organizer. Drawer Four is left open for easy storage of large, bulky items.



### STORAGE CABINET SPECIFICATIONS

Model	Outside Dimension	Weight Lbs.
2-Drawer	16-3/4" x 16" x 14-1/8"	32
4-Drawer	16-3/4" x 16" x 14-1/8"	38

StorIt-Cabinets are available as an option on the following Gun Safe models:

BFX7250\*, BFX7240, BFX6636, BFX6030, BFII7250\*, BFII7240, BFII6636, BFII6030, NF6036E5, NF6030E5.

Cabinets do not fit any 6032, 6024 or 5924 models or the TF Series.

\*No kit needed for installation on BFX7250 & BFII7250 - Cabinets slide right in.

**NOTE: DIFFERENT INTERIOR NEEDS TO BE ORDER WHEN ORDERING CABINETS. REFERENCE INTERIOR KITS ON PRICE SHEET.**

## THE SAFE CLOAK

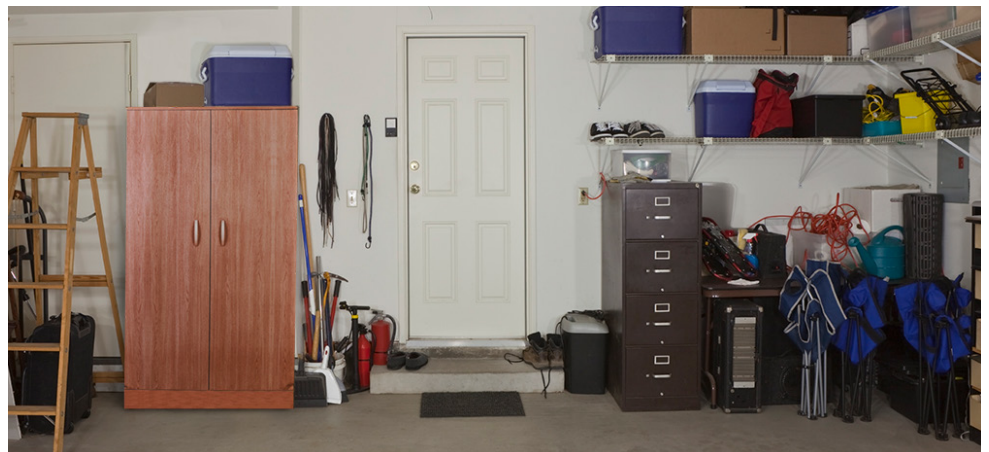

### HIDE YOUR GUN SAFE IN PLAIN SIGHT!

Instantly disguise your gun safe with American Security's Safe Cloak. Available in five different sizes, the Safe Cloak attaches to your gun safe to instantly disguise it as a wood cabinet. Strong magnets and a sewn-in PVC board at the top easily and securely hold the cloak in place. The thermal-transfer, four-color wood-cabinet print is so good, it will fool not only passersby, but guests as well.

Available in the following sizes: 6024, 6030, 6636, 7240, 7250.

# ELECTRONIC AND MECHANICAL LOCK OPTIONS

For quick and easy entry, an electronic lock is the lock of choice. These locks are powered by batteries located in the keypad and allow you to change your combination anytime.



**ESL10**  
Available in Brass, Chrome and Black Nickel Finish



**ESL5**  
Available in Chrome and Black Nickel Finish



**ROTOBOLT REDUNDANT LOCK**  
The convenience of an Electronic lock and the trusted reliability of a mechanical combination lock.



**SPYPROOF DIAL**  
Also available with key locking feature.



**KEY LOCKING SPYPROOF DIAL**  
Restricts unauthorized viewing while dialing the combination, as well as providing dual custody control.

## OTHER OPTIONS



**.50 CALIBER HANDLE**  
Available in Black Nickel BFX, BFII & NF Gun Safes only.



**POWER STRIP**  
3-Outlet Power Strip with two USB ports and removable cord.



**36" LED LIGHT KIT**  
Has two 36" light strips with high-intensity white LED lights and a motion sensor that automatically turns the lights on when motion is detected. The lights turn off 30 seconds after motion has stopped. This light kit can be installed on any American Security® safe and is also available as a retrofit kit.



**DESICCANT**  
Prevents rust and moisture damage. Recommended for safes without electrical access.



**JEWELRY DRAWER**  
Velvet lined jewelry drawer that can be installed on top or underneath any shelf larger than 10" wide and 13<sup>13</sup>/<sub>16</sub> deep.



**DEHUMIDIFIER ROD**  
Keeps your guns safe from the threat of rust, pitting and moisture damage. Electrical access required.



**8" COMPACT LED LIGHT KIT**  
Features two 8" light strips with high-intensity white LED lights and a motion sensor that automatically turns the lights on when motion is detected. Comes with battery box.



**PISTOL RACK**  
This four-gun rack is ideal for organizing pistols inside your safe.  
**Available While Supplies Lasts!**

### PREMIUM UPGRADE PACKAGE FOR BFX, NF AND SF SAFES

When you choose to upgrade your American Security BFX, NF or SF Series with a Premium Package, we'll add on some of our most popular options, including the Dehumidifier Rod, a Jewelry Drawer, an LED light kit\*, and a 3-outlet power strip with USB.

\*LED light kit standard on BFII, BFX, and RF gun safes



# GUN SAFES AT A GLANCE

Model	Exterior Dimensions	Gun Capacity	Weight Lbs.	PDO Included	Bolts	Bolt Dia.	Relocker
<b>RF SERIES</b>							
<b>RF703620X6</b>	76" x 42" x 29-1/4"	12-12-12-24-36+2 Gun or 58 + 2 Gun	4,578	Yes	10	1-1/2"	Yes
<b>RF582820X6</b>	64" x 34" x 29-1/4"	12-12-12-24 + 2 Gun	3,418	Yes	10	1-1/2"	Yes
<b>RF6528</b>	72" x 35" x 29-1/4"	12-12-12-24 + 2 Gun	3,455	Yes	10	1-1/2"	Yes
<b>BFII SERIES</b>							
<b>BFII7250</b>	71-1/4" x 50" x 28"	14-14-14-28-42 + 2 Gun or 73 + 2 Gun	2,438	Yes	10	1-1/2"	Yes
<b>BFII7240</b>	71-1/4" x 40" x 26"	12-12-12-24-36 + 2 Gun or 58 + 2 Gun	1,991	Yes	10	1-1/2"	Yes
<b>BFII6636</b>	65-1/4" x 36" x 26"	12-12-24 + 2 Gun	1,716	Yes	10	1-1/2"	Yes
<b>BFII6030</b>	59-1/4" x 30" x 26"	11-11-22 + 2 Gun	1,395	Yes	10	1-1/2"	Yes
<b>BFII6032</b>	59-1/4" x 30" x 21"	9-9-18 + 2 Gun	1,244	Yes	10	1-1/2"	Yes
<b>BFII6024</b>	59-1/4" x 24" x 21"	8-8-16 Gun + 1 Gun	1,067	Yes	10	1-1/2"	Yes
<b>BFX SERIES</b>							
<b>BFX7250</b>	71-1/4" x 50" x 28"	14-14-14-28-42 + 2 Gun or 73 + 2 Gun	1,789	Yes	16	1-1/2"	Yes
<b>BFX7240</b>	71-1/4" x 40" x 26"	12-12-12-24-36 + 2 Gun or 58 + 2 Gun	1,585	Yes	16	1-1/2"	Yes
<b>BFX6636</b>	65-1/4" x 36" x 26"	12-12-24 + 2 Gun	1,319	Yes	16	1-1/2"	Yes
<b>BFX6030</b>	59-1/4" x 30" x 26"	11-11-22 + 2 Gun	1,036	Yes	14	1-1/2"	Yes
<b>BFX6032</b>	59-1/4" x 30" x 21"	9-9-18 + 2 Gun	913	Yes	14	1-1/2"	Yes
<b>BFX6024</b>	59-1/4" x 24" x 21"	8-8-16 Gun + 1 Gun	720	Yes	10	1-1/2"	Yes
<b>NF SERIES</b>							
<b>NF6036E5</b>	59" x 36" x 26"	17-17-34 + 2 Gun	977	Yes	14	1-1/2"	Yes
<b>NF6030E5</b>	59" x 30" x 26"	14-14-28 + 2 Gun	788	Yes	14	1-1/2"	Yes
<b>NF6032E5</b>	59" x 30" x 21"	9-9-18 + 2 Gun	761	Yes	14	1-1/2"	Yes
<b>NF5924E5</b>	59" x 24" x 18"	8-8-16 Gun + 1 Gun	600	Yes	14	1-1/2"	Yes
<b>SF SERIES</b>							
<b>SF7240E5</b>	72" x 40" x 26"	15-15-15-30-45 + 2 Gun	1,086	Yes	14	1-1/4"	Yes
<b>SF6036E5</b>	59" x 36" x 26"	17-17-34 + 2 Gun	840	Yes	14	1-1/4"	Yes
<b>SF6030E5</b>	59" x 30" x 26"	15-15-30 + 2 Gun	748	Yes	14	1-1/4"	Yes
<b>SF6032E5</b>	59" x 30" x 21"	11-11-22 + 2 Gun	662	Yes	14	1-1/4"	Yes
<b>TF SERIES</b>							
<b>TF5924E5</b>	59" x 24" x 18"	8-8-16 Gun + 1 Gun	388	Yes	14	1-1/4"	Yes
<b>TF5517E5</b>	55-1/4" x 17-3/4" x 16"	11 Gun	286	Yes	8	1"	Yes

Dimensions listed are exterior dimensions. Add 2<sup>3</sup>/<sub>4</sub>" on all BF and NF safes and 2" on all other safes to overall depth for lock and handle.

# GUN SAFES AT A GLANCE

	Warranty	U.L. Listing	Thickness		Fire Rating	Standard Lock	Handle	Standard Interior
			Door	Body				
	Lifetime Theft & Fire	TL30-X6	6	3"	120 min / 1800°	Spy-Proof, Key-Locking Dial, ESL5, ESL10	5-Spoke	Tan Pin-Dot
	Lifetime Theft & Fire	TL30-X6	6	3"	120 min / 1800°	Spy-Proof, Key-Locking Dial, ESL5, ESL10	5-Spoke	Tan Pin-Dot
	Lifetime Theft & Fire	TL30	6	3"	120 min / 1800°	Spy-Proof, Key-Locking Dial, ESL5, ESL10	5-Spoke	Tan Pin-Dot
	5-year parts and labor warranty when purchased with a factory installed American Security lock.  Special lifetime warranty for damage from burglary attempts and fire.	RSC Level II	4-3/4" / 1/2"	2-1/4"	ETL 120 min / 1200°	Spy-Proof, Key-Locking Dial, ESL5, ESL10	5-Spoke	Tan Pin-Dot
		RSC Level II	4-3/4" / 1/2"	2-1/4"	ETL 120 min / 1200°	Spy-Proof, Key-Locking Dial, ESL5, ESL10	5-Spoke	Tan Pin-Dot
		RSC Level II	4-3/4" / 1/2"	2-1/4"	ETL 120 min / 1200°	Spy-Proof, Key-Locking Dial, ESL5, ESL10	5-Spoke	Tan Pin-Dot
		RSC Level II	4-3/4" / 1/2"	2-1/4"	ETL 120 min / 1200°	Spy-Proof, Key-Locking Dial, ESL5, ESL10	5-Spoke	Tan Pin-Dot
		RSC Level II	4-3/4" / 1/2"	2-1/4"	ETL 120 min / 1200°	Spy-Proof, Key-Locking Dial, ESL5, ESL10	5-Spoke	Tan Pin-Dot
		RSC Level II	4-3/4" / 1/2"	2-1/4"	ETL 120 min / 1200°	Spy-Proof, Key-Locking Dial, ESL5, ESL10	L-Handle	Tan Pin-Dot
	5-year parts and labor warranty when purchased with a factory installed American Security lock.  Special lifetime warranty for damage from burglary attempts and fire.	RSC Level I	4-5/8" / 3/8"	2"	ETL 120 min / 1200°	Spy-Proof, Key-Locking Dial, ESL5, ESL10	5-Spoke	Tan Pin-Dot
		RSC Level I	4-3/4" / 1/2"	2"	ETL 120 min / 1200°	Spy-Proof, Key-Locking Dial, ESL5, ESL10	5-Spoke	Tan Pin-Dot
		RSC Level I	4-3/4" / 1/2"	2"	ETL 120 min / 1200°	Spy-Proof, Key-Locking Dial, ESL5, ESL10	5-Spoke	Tan Pin-Dot
		RSC Level I	4-3/4" / 1/2"	2"	ETL 120 min / 1200°	Spy-Proof, Key-Locking Dial, ESL5, ESL10	5-Spoke	Tan Pin-Dot
		RSC Level I	4-3/4" / 1/2"	2"	ETL 120 min / 1200°	Spy-Proof, Key-Locking Dial, ESL5, ESL10	5-Spoke	Tan Pin-Dot
		RSC Level I	4-5/8" / 3/8"	2"	ETL 120 min / 1200°	Spy-Proof, Key-Locking Dial, ESL5, ESL10	3-Spoke	Tan Pin-Dot
	Lifetime Theft & Fire	RSC Level I	4-1/4" / 1/4"	11 ga.	ETL 90 min / 1200°	ESL5 Electronic Lock	5-Spoke	Gray Fabric
	Lifetime Theft & Fire	RSC Level I	4-1/4" / 1/4"	11 ga.	ETL 90 min / 1200°	ESL5 Electronic Lock	5-Spoke	Gray Fabric
	Lifetime Theft & Fire	RSC Level I	4-1/4" / 1/4"	11 ga.	ETL 90 min / 1200°	ESL5 Electronic Lock	5-Spoke	Gray Fabric
	Lifetime Theft & Fire	RSC Level I	4-1/4" / 1/4"	11 ga.	ETL 90 min / 1200°	ESL5 Electronic Lock	5-Spoke	Gray Fabric
	Lifetime Theft & Fire	B-Rate	3-5/8" / 3/16"	12 ga.	ETL 60 min / 1200°	ESL5 Electronic Lock	3-Spoke	Gray Fabric
	Lifetime Theft & Fire	B-Rate	3-5/8" / 3/16"	12 ga.	ETL 60 min / 1200°	ESL5 Electronic Lock	3-Spoke	Gray Fabric
	Lifetime Theft & Fire	B-Rate	3-5/8" / 3/16"	12 ga.	ETL 60 min / 1200°	ESL5 Electronic Lock	3-Spoke	Gray Fabric
	Lifetime Theft & Fire	B-Rate	3-5/8" / 3/16"	12 ga.	ETL 60 min / 1200°	ESL5 Electronic Lock	3-Spoke	Gray Fabric
	Lifetime Theft & Fire	B-Rate	3-5/8" / 3/16"	14 ga.	30 min / 1200°	ESL5 Electronic Lock	3-Spoke	Gray Fabric
	Lifetime Theft & Fire	B-Rate	3-1/4" / 3/16"	14 ga.	30 min / 1200°	ESL5 Electronic Lock	"L" Handle	Gray Fabric



# THE INDUSTRY LEADER FOR OVER 75 YEARS

Since 1946 American Security® has protected the assets of our clients throughout the world by providing a broad array of safes and consulting services with the highest degree of quality, integrity and responsiveness. Customers have trusted American Security safes for generations. The design of each American Security safe draws on 75 years of experience on protecting the physical assets of our customers. There aren't many criminals with 75 years of experience, so we think that gives us the advantage.

Before the American Security name is attached, each safe must undergo a rigid 28-point inspection. In addition, every American Security safe undergoes the industry's most comprehensive testing program. American Security uses independent agencies such as Underwriters Laboratories to put our designs to the test. We maintain the tightest tolerances and highest standards of fit and finish in the industry.

Our commitment doesn't end there. We have built our company on the commitment to offer the best service in the industry which will insure that American Security remains the industry leader.

Our corporate center is staffed with highly trained Customer Service Representatives and our Service Department is supported by 7,500 factory-trained technicians throughout the world. Technicians are available 24 hours a day, 365 days a year to answer questions and help solve problems with any safe shipped anywhere in the world. We have been providing safes and security solutions to the banking industry since 1946. This type of high security technology is built right into our gun safes.

We produce over 60,000 safes each year and we take protecting our customers' assets very seriously. That's how we got to be the largest security safe manufacturer in the world, and that's why you can't buy a better gun safe than an American Security safe.

Simply put, our reputation is built on product design, innovative technology and the best support in the industry.

It has worked for us for 75 years and it ensures our complete customer satisfaction. The choice is easy:



## American Security

11925 Pacific Avenue, Fontana, CA 92337

[americansecuritysafes.com](http://americansecuritysafes.com)